

Catalog Number	
Notes	Type



Low-profile Straight-blade Louver



FEATURES & SPECIFICATIONS

INTENDED USE — The new Z series straight-blade louver (SBL) products offer engineers and specifiers a contemporary designed lighting fixture which provides the ideal balance of appearance, performance and efficiency. Versatile for a wide range of spaces from retail, commercial, merchandising and task applications, this new low-profile SBL series provides the perfect solutions for general and reduced-space areas.

CONSTRUCTION — All metal components are constructed of code-gauge cold-rolled steel and are painted with a 92% reflective enamel powder paint finish. Precision-designed blade assemblies are positively retained to the housing with safety cables for ease of cleaning and re-lamping. Conveniently located top access plate and KOs provide contractors easy wiring connections.

Finish: All parts are painted after fabrication with a high-gloss, white enamel finish (white standard). Five-stage iron phosphate pretreatment ensures superior paint adhesion and rust resistance. Similar to the Z strip, three additional paint finishes are available; black (MB), smoke gray (SKGY) and galvanized (GALV). For RAL finishes; consult factory

OPTICS — Straight blade louvers available in 48" and 46" increments, either solid or perforated versions. Housing design is offered in solid and two different uplight offerings (8% and 5%). Special uplight versions are available; consult factory.

ELECTRICAL — Thermally protected, resetting, Class P, HPF non-PCB, UL listed. Suitable for damp locations. AWN, TFN or THHN wire used throughout, rated for required temperatures.

INSTALLATION — All SBL versions come fully assembly in a tab lock carton for simple, easy installation. Additionally for continuous-row application, each SBL includes our patented three-point row connector and housing clips for straighter, faster row mounting.

This product series can be surface, stem or aircraft cable mounted.

Specifications are subject to change without notice.

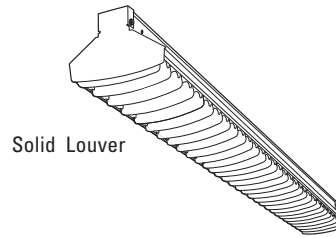

Solid Louver

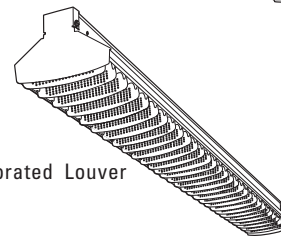

Perforated Louver

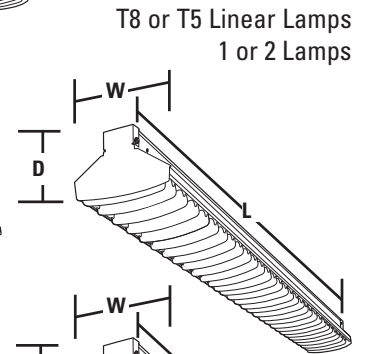

Specifications

Length: T8: 48 (121.9) or 96 (243.8)

T5: 46 (116.8) or 92 (233.7)

Width: 6-9/16 (166.7)

Depth: 3-15/16 (100.0)

All dimensions are inches (centimeters).

ORDERING INFORMATION

For shortest lead times, configure product using **standard options (shown in bold)**.

Example: Z 1 32 SBL MVOLT GEB10IS

Series	Lamp type	Voltage	Options	Finish
Z Low-profile	28T5 28W T5 (46")	MVOLT	SSR Miro® 4 specular insert	(blank) White
For tandem double-length unit, add prefix T. Example: TZ	32 32W T8 (48")	347	GLR Internal fast-blow fuse (add X for external) ¹	MB Black
	54T5HO 54W T5HO (46")	Others available	GMF Internal slow-blow fuse (add X for external) ¹	GALV Galvanized
			PLR_ Plug in wiring, specify number of branch circuits and hotwires (A-black, B-Red, C-Blue, AB or AC)	SKGY Smoke gray
			TILW Tandem in-line wiring	
			EL55 Emergency battery pack (nominal 390-700 lumens); consult factory for additional battery packs ^{1,2}	
			EL65 Emergency battery pack (nominal 725-1325 lumens) ^{1,2}	
			CSA CSA Certified	
			NOM NOM Certified	
			NOTES:	
			1	Specify voltage (available 120/277V).
			2	Not available with CSA Certified.
			3	For unit mounting, order two per fixture. For row mounting, order one per fixture plus one per row.

Z Straight-blade Louver Striplight

MOUNTING DATA

For unit or row installation, surface or stem mounting.

Unit installation — Minimum of two hangers required.

Row installation — One hanger per channel plus one per row required.

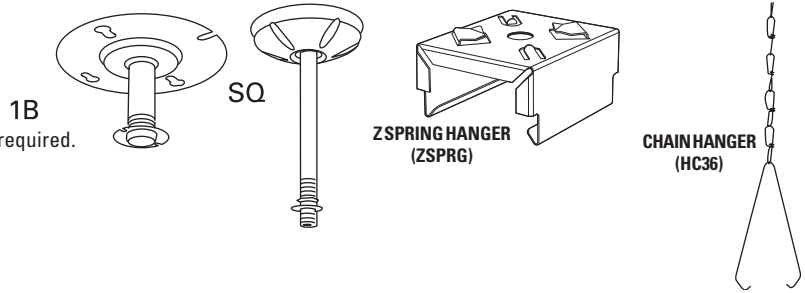

DIMENSIONS

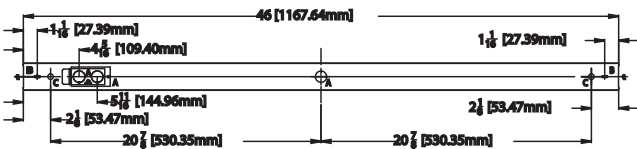
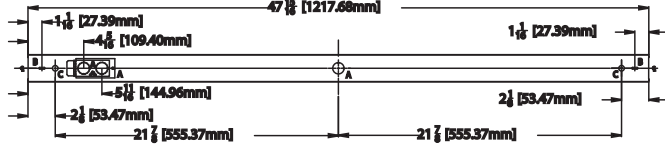
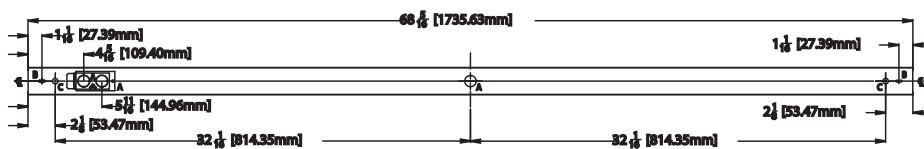
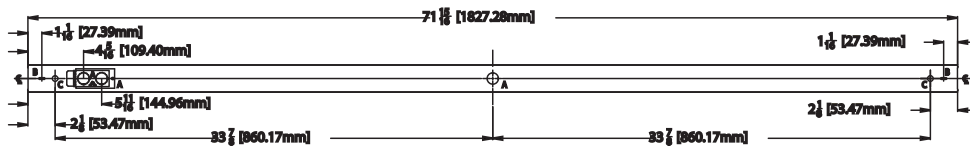
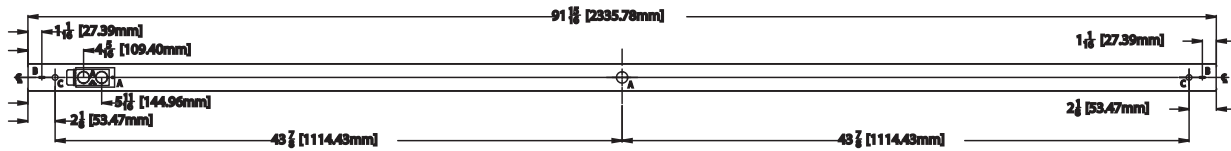
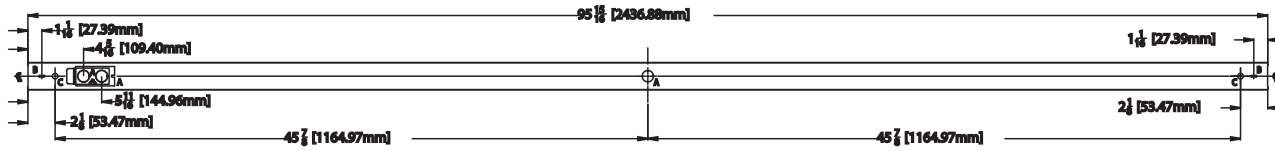

K. O. Dimensions

A = 7/8 (22) Dia. K.O.

B = 5/32 (3.9) x 1/2 (12.7) slot

C = 7/16 (11.1) Dia. K.O.

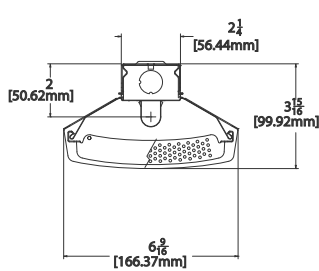

One-lamp T5

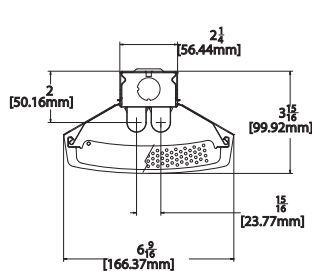

Two-lamp T5

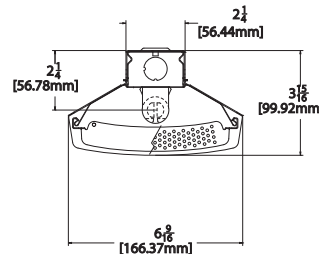

One-lamp T8

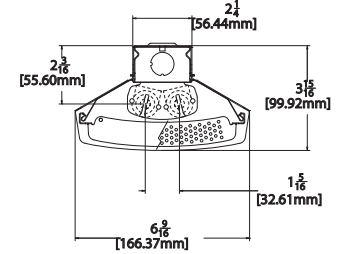

Two-lamp T8

PHOTOMETRICS

Consult factory.



An Acuity Brands Company