

lumenpulse™



Area Pole Guide
ASSHTO Standards

Let us help you meet your area needs by taking into account the natural elements for each geological region.

The Area Pole Guide is an industry reference tool that will help you choose your area poles, pole arms, accessories, and luminaries that best suit your project and AASHTO EPA requirements.

02	Configuring Your Builds	20	Luminaire EPA Tables
04	Junction Compatibility Diagram	22	Decorative Arm and Banner EPA Tables
06	Product Code Alignment	24	AASHTO Wind Map
08	Luminaire and Decorative Arm Compatibility	26	Straight Pole EPA Guide
10	Luminaire and Decorative Pole Compatibility	50	Muffler Pole EPA Guide
12	Decorative Arm and Pole Compatibility	74	Lumentech Smart Pole EPA Guide
14	EPA Pole Guide	86	Finishes
16	Pole Basics	87	Pole Packaging
18	How to Calculate EPA	89	Conditions and References

Configuring Your Builds

There are several factors to consider when choosing the right area products for your projects. Once you have chosen a variant of the components shown on the opposite page, you can use this guide to help you calculate if the area modules you have decided on are the safest fit for your region and design.

THIS GUIDE IS FOR REFERENCE PURPOSES ONLY.
ALL AREA COMPONENT INSTALLATIONS NEED TO BE VALIDATED BY A QUALIFIED ENGINEER.

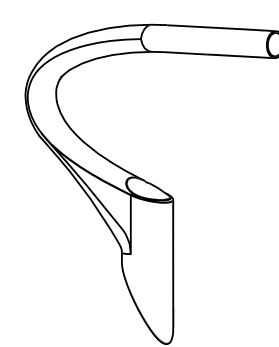

- 1 Select your Lumenpulse outdoor **area luminaire**.
- 2 Pick a **decorative arm** that suits your project's design needs.



3 Add **accessories** and choose **options** to make your project stand out.



4 Calculate the EPA for your luminaire, decorative arm, and accessories.



5 Choose the right pole that meets or exceeds the EPA calculations done in Step 4. Options to consider:

Select Shape

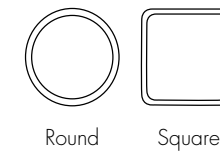

Round Square

Choose Material



Aluminium Steel

Choose Pole Height



Up to 30 ft

Choose Installation Type

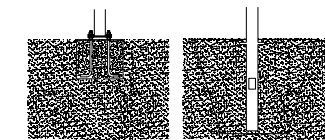

Standard Direct Burial

Up to 30 ft

Standard

Direct Burial

⁽¹⁾ Direct Burial is available for Straight Poles only. Maximum height of 16 ft for Ø4 in and Ø5 in aluminum poles or Ø4 in steel poles. Maximum height of 26 ft for Ø6 in aluminum poles or Ø5 in and Ø6 in steel poles.

⁽²⁾ These steps are suggestions only. Each variant can affect total EPA. Please verify with a qualified engineer before installation.

Junction Compatibility Diagram

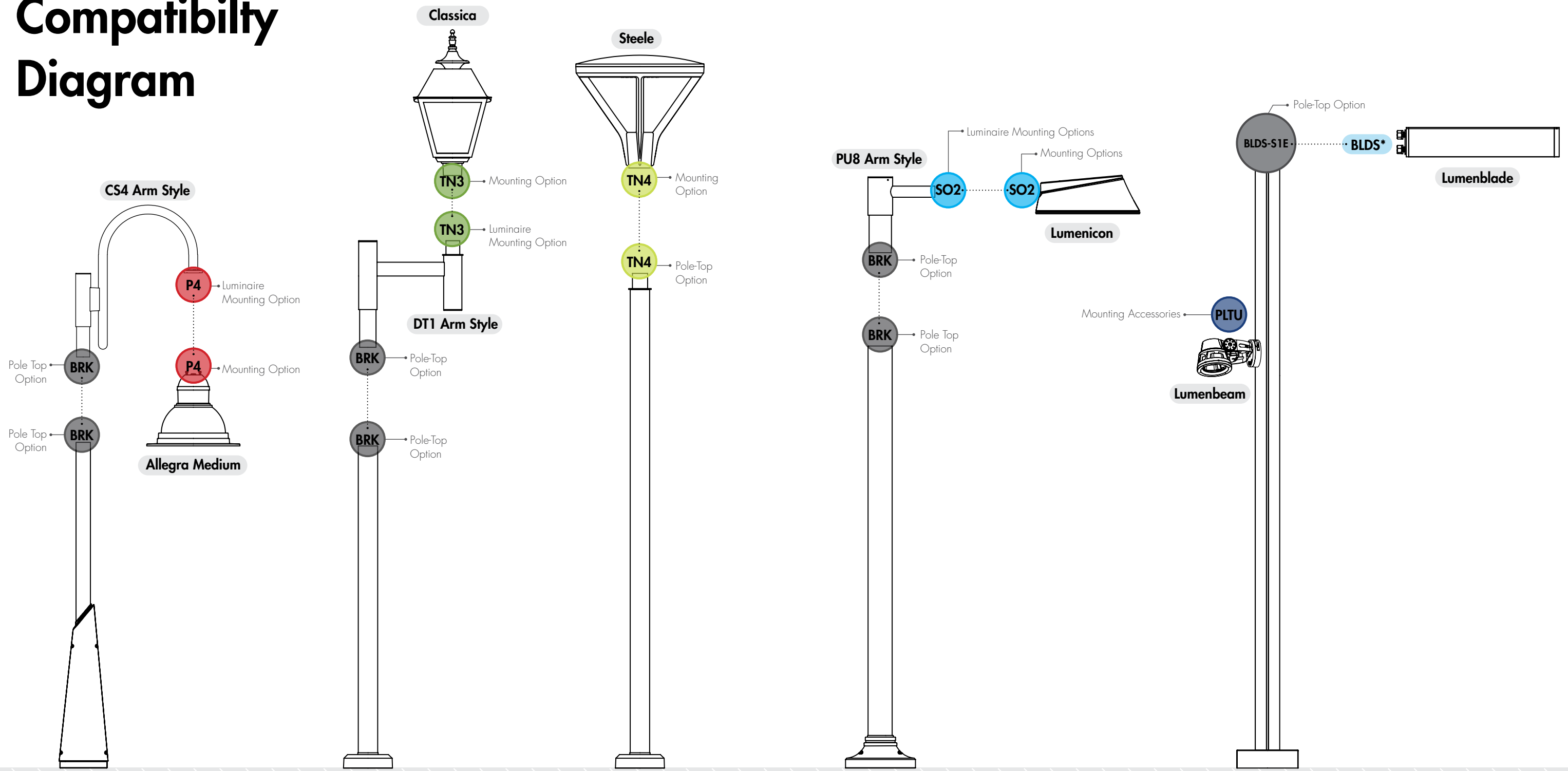

Pendant-Mount Luminaires

Pendant-Mount Luminaires always need a Decorative Arm to be mounted on a Decorative Pole.

Top-Mount Luminaires

Top-Mount luminaires are mounted on Decorative Arms.

Post-Top-Mount Luminaires

Post-Top Mount luminaires are mounted directly on Decorative Poles.

Side-Mount Luminaires

Side-Mount luminaires can be mounted on Decorative Arms or directly onto Decorative Poles.

*SPA6T A Pole Mounting Adaptor is required for Lumenblade Small when combined with a Lumentech Smart Pole 6" Square.

Product Code Alignment

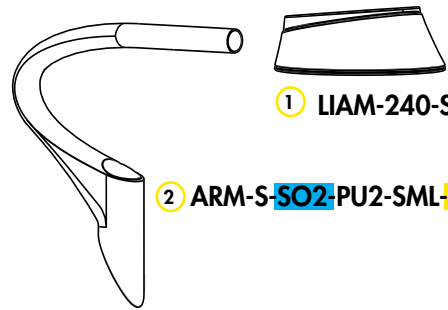

① LIAM-240-SSL-L30-30K-CRI 70-5-BRZ-DIM-CRC-**SO2**

② **ARM-S-SO2-PU2-SML-4-R-L-BRK**-BRZ-CRC

③ **PL-S-4-AL-R-16-L-BRZ-WB-BRK**-DRG-AB

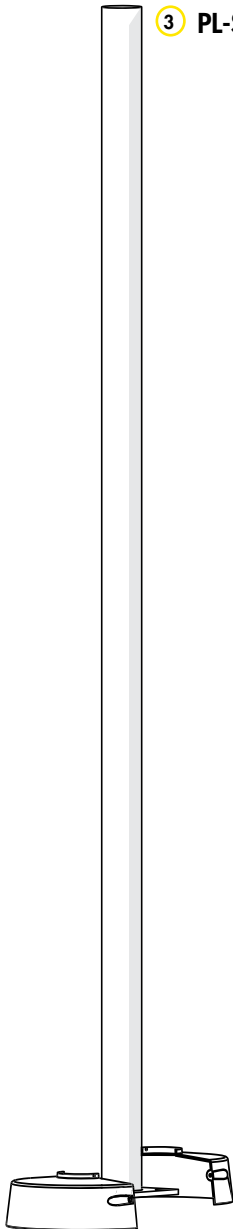

① Configure your area luminaire and take note of your **Mounting Option Code: SO2**.

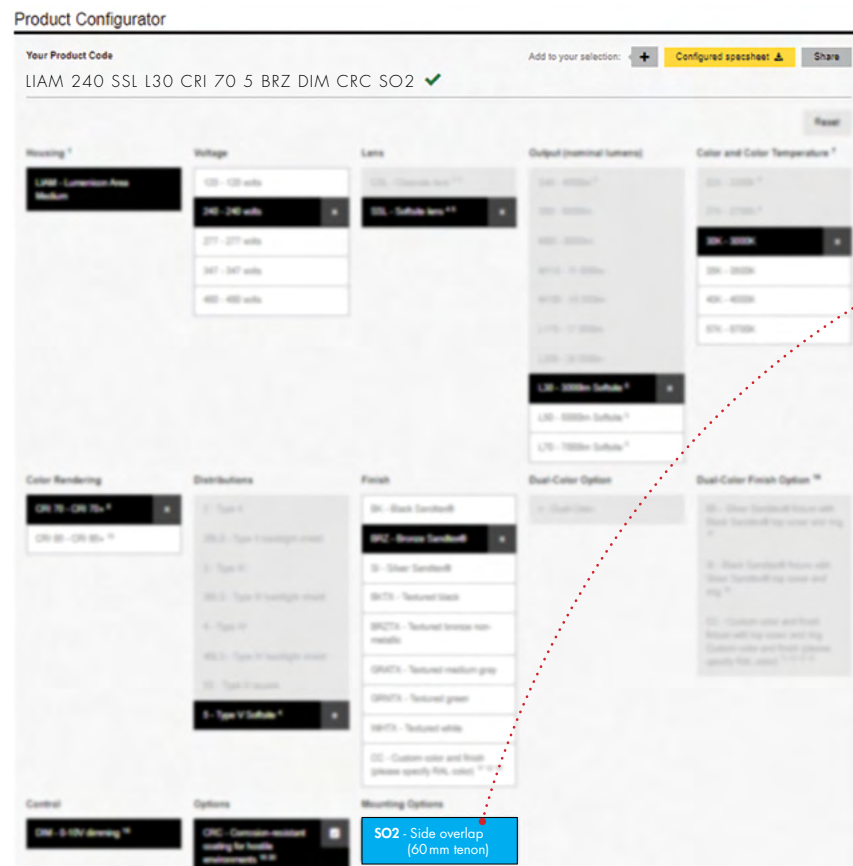

② Match the **Side-Mount Decorative Arm** with the luminaire's **Mounting Option Code: SO2**.

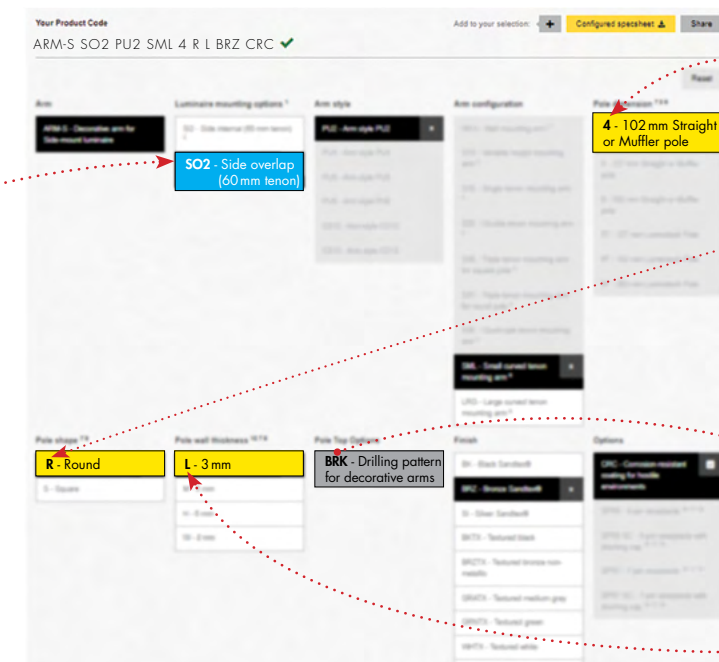



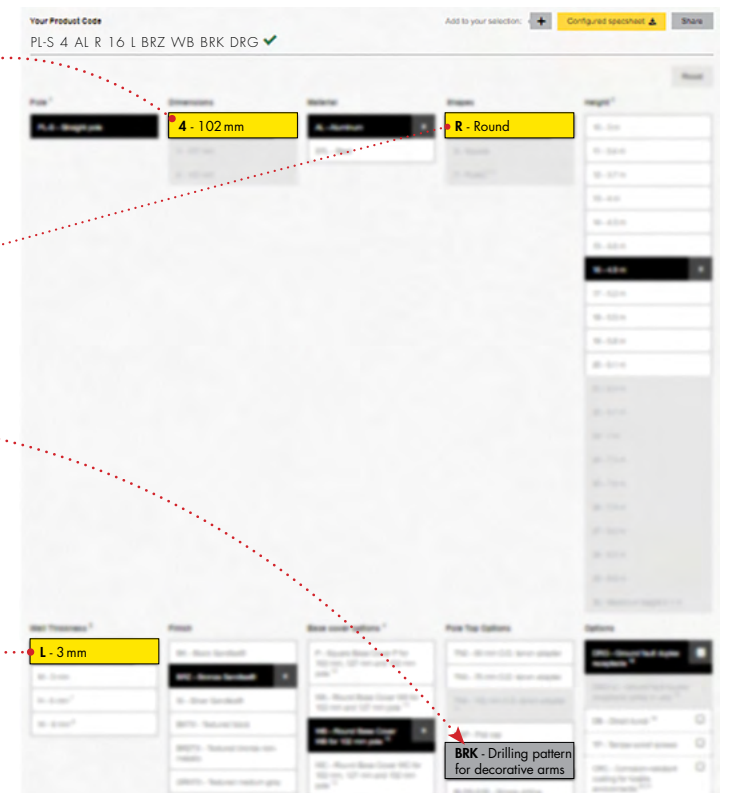

③ Configure the **Decorative Pole** for your project and make sure that the **Decorative Arm** is properly configured (**4** Pole Dimensions/**R** Shape/**L** Wall Thickness).





Luminaire and Decorative Arm Compatibility

Pendant-Mount Fixture Arm Style Mounting Options

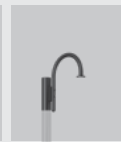

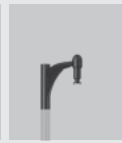

 Allegra Small

 CM0
  DM0
  DT6
  CS2
  CS4

 CS6
  CS12
  CS13
  MC5

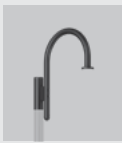
P3
Pendant Small
3 Bolts

 Allegra Medium



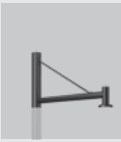
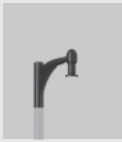

 CS2
  CS4
  DT6
  CS6
  CS12

 CS13
  MC5

P4
Pendant Medium
4 Bolts

Side-Mount Fixture Arm Style Mounting Options



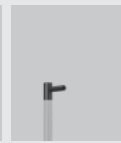

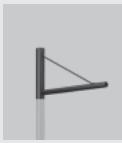
 Pure100

 PU2-SML
  PU2-LGR
  PU4
  PU5
  PU8

 CS12
  CS13

SI2
Side Internal
2 3/8 in

 Allegra Medium*





 PU2-LGR
  PU4
  PU5
  CS12
  CS13

SI2
Side Internal
2 3/8 in

* SI2 tenon adaptor included with Allegra Medium SI2 mounting option.

Side-Mount Fixture Arm Style Mounting Options

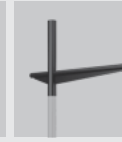
 Lumenicon Area Medium

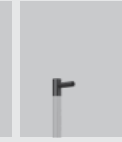

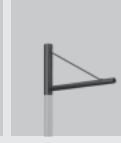
 PU2-SML
  PU2-LGR
  PU4
  PU5
  PU8

 CS12
  CS13

SO2
Side Overlap
2 3/8 in

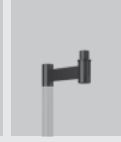

Top-Mount Fixture Arm Style Mounting Options

 Prestigia

 DT1*
  DT6
  MC1*

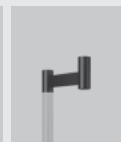

TN3
Tenon 3 in

 Classica

 DT1*
  DT6
  MC1*

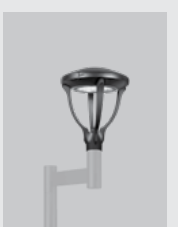
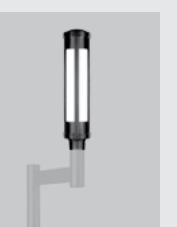
TN3 **TN4**
Tenon 3 in Tenon 4 in

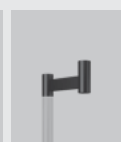
 Pure TV-Y
  Element Post-Top

 DT1
  DT6
  MC1

TN4
Tenon 4 in

 Steele

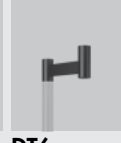
 DT1
  DT6

TN4
Tenon 4 in

* Some limitation may apply

Luminaire and Decorative Pole Compatibility

Post-Top-Mount Luminaire Mounting Option Pole-Top Option



Classica
Prestigia

Decorative Pole Compatibility

Pole	Round				Square				Fluted	
	Ø4"	Ø5"	Ø6"	Ø8"	4"	5"	6"	8"	Ø4"	Ø5"
PL-S										
PL-M		TN3		N/A		TN3		N/A		TN3
PL-T										

TN3

Tenon 3 in



Classica
Pure TV-Y

Decorative Pole Compatibility

Pole	Round				Square				Fluted	
	Ø4"	Ø5"	Ø6"	Ø8"	4"	5"	6"	8"	Ø4"	Ø5"
PL-S										
PL-M		TN4		N/A		TN4		N/A		TN4
PL-T										

TN4*

Tenon 4 in



Steele
Element Post-Top

Decorative Pole Compatibility

Pole	Round				Square				Fluted	
	Ø4"	Ø5"	Ø6"	Ø8"	4"	5"	6"	8"	Ø4"	Ø5"
PL-S										
PL-M		TN4		N/A		TN4		N/A		TN4
PL-T										

TN4

Tenon 4 in

*TN4 pole-top option not required with 4" round pole.



Lumenquad Family

Decorative Pole Compatibility

Pole	Round				Square				Fluted	
	Ø4"	Ø5"	Ø6"	Ø8"	4"	5"	6"	8"	Ø4"	Ø5"
PL-S										
PL-M		TN4		N/A		TN4		N/A		TN4
PL-T										

TN4

Tenon 4 in

Post-Top-Mount Luminaire Mounting Accessories Pole-Top Option



Lumenbeam Family

Decorative Pole Compatibility

Pole	Round				Square				Fluted	
	Ø4"	Ø5"	Ø6"	Ø8"	4"	5"	6"	8"	Ø4"	Ø5"
PL-S										
PL-M		LBSTN4 LBMTN4 LBNTN4 LBGTN4		N/A		LBSTN4 LBMTN4 LBNTN4 LBGTN4		N/A		LBSTN4 LBMTN4 LBNTN4 LBGTN4
PL-T										

TN4

Tenon 4 in

Side-Mount Luminaire Mounting Option Pole-Top Option



Pure 100

Decorative Poles Compatibility

Pole	Round				Square			Fluted		
	Ø4"	Ø5"	Ø6"	Ø8"	4"	5"	6"	8"	Ø4"	Ø5"
PL-S	PU1-S1X-4R PU1-S1E-4R	PU1-S1X-5R PU1-S1E-5R		N/A					PU1-S1X-4R PU1-S1E-4R	PU1-S1X-5R PU1-S1E-5R
PL-M	PU1-S2E-4R PU3-S1E-4R	PU1-S2E-5R							PU1-S2E-4R PU3-S1E-4R	PU1-S2E-5R PU3-S1E-5R
PL-T		N/A				N/A				N/A

N/A

No pole-top option required



Lumenblade Small

Decorative Pole Compatibility

Pole	Round				Square				
	Ø4"	Ø5"	Ø6"	Ø8"	4"	5"	6"	8"	
PL-S									
PL-M	RPA4S	RPA5S	RPA6S		N/A	SPA4	SPA5	SPA6	
PL-T	N/A	RPA5TS	RPA6ST			N/A	N/A	SPA6T	N/A

BLDS-S1E

Simple drilling pattern for Lumenblade Small

BLDS-S2E

Double drilling pattern for Lumenblade Small

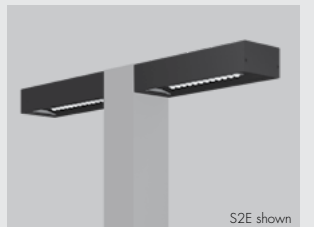

Lumenblade Medium

Decorative Pole Compatibility

Pole	Round				Square			
	Ø4"	Ø5"	Ø6"	Ø8"	4"	5"	6"	8"
PL-S			RPA6M					
PL-M	N/A	N/A	RPA6M	N/A	N/A	N/A	SPA6	N/A
PL-T			RPA6TM				SPA6T	

BLDM-S1E

Simple drilling pattern for Lumenblade Medium

BLDM-S2E

Double drilling pattern for Lumenblade Medium



Lumenquad Family

Decorative Pole Compatibility

Pole	Round				Square				Fluted	
	Ø4"	Ø5"	Ø6"	Ø8"	4"	5"	6"	8"	Ø4"	Ø5"
PL-S	PM4-1 PM4-2	PM5-1 PM5-2							PM4-1 PM4-2	PM5-1 PM5-2
PL-M	PM4-1 PM4-2	PM5-1 PM5-2	n/a						PM4-1 PM4-2	PM5-1 PM5-2
PL-T	N/A	UY	UY		N/A	UY				N/A

N/A

No pole-top option required

Side-Mount Luminaire Mounting Accessories Pole-Top Option

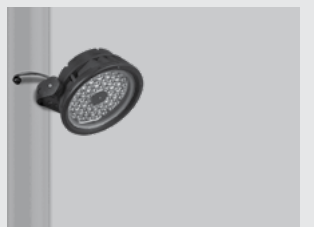

Lumenbeam Family

Decorative Pole Compatibility

Pole	Round				Square				Fluted	
	Ø4"	Ø5"	Ø6"	Ø8"	4"	5"	6"	8"	Ø4"	Ø5"
PL-S	PM4-1 PM4-2	PM5-1 PM5-2							PM4-1 PM4-2	PM5-1 PM5-2
PL-M	PM4-1 PM4-2	PM5-1 PM5-2							PM4-1 PM4-2	PM5-1 PM5-2
PL-T	N/A	UY	UY		N/A	UY				N/A

N/A

No pole-top option required

Decorative Arm and Decorative Pole Compatibility

Pendant-Mount Arm Style	Decorative Pole Compatibility			Pole-Top Option
	4" Pole	5" Pole	6" Pole	
CS2 				BRK
CS4 				BRK
CS6-S1E S1E Configuration 4" pole: N/A, 5" pole: BRK No pole-top option required			N/A	BRK No pole-top option required with S1E 4" pole
CS6-S2E S2E Configuration			N/A	BRK
CS12 				BRK
CS13 				BRK
DT6 				BRK
MC5 				BRK

Round Pole
 Fluted Pole
 Square Pole

Top-Mount Arm Style	Decorative Pole Compatibility			Pole-Top Option
	4" Pole	5" Pole	6" Pole	
DT1 				BRK
DT6 				BRK
MC1 				TNMC1

Side-Mount Arm Style	Decorative Pole Compatibility			Pole-Top Option
	4" Pole	5" Pole	6" Pole	
PU2-LGR N/A No pole-top option required		N/A	N/A	N/A No pole-top option required
PU4 				BRK
PU5 				BRK
PU8 				BRK
CS12 				BRK
CS13 				BRK



EPA Pole Guide

Built to Withstand the Elements



Designed to resist the elements, such as wind, ice, and extreme locations, our poles are engineered to support luminaires through most types of weather.

To ensure their success, the appropriate Effective Projected Area (EPA) calculation helps make the installation of area lighting safe and to increase the longevity of a lighting installation.

The EPA is a coefficient that determines how much force a luminaire can apply to its mounting brackets or pole at a given wind velocity. This value is used in combination with a luminaire's weight to determine the mounting requirements for a particular application.

Special Considerations

Lumenpulse offers a number of solutions that tackle special considerations and conditions not included in standard EPA calculations. To learn more, please consult a Lumenpulse representative. Some additional factors that influence the stability of a pole installation:

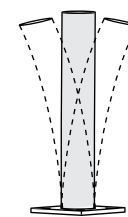

Vibration



Flat and Open Spaces

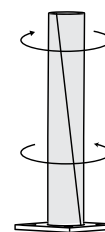

Torsion



Height of Installation Above Ground



Wall Thickness

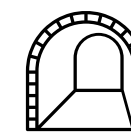

Tunnel Effect

Pole Basics

ALUMINUM vs STEEL

WHY CHOOSE ONE OVER ANOTHER?



Aluminum Poles

- Light weight
- Ease of machining
- Ease of manufacturing
- Superb corrosion resistance
- Highly recyclable



Steel Poles

- Recommended for high/extreme wind situations
- Recommended for taller heights
- Greater load-bearing capacity
- Greater vibration resistance

Anchorage Details

Anchor Bolts

Anchor bolts are used to secure poles into concrete foundations. The listed EPAs are calculated using the Lumenpulse Anchor Bolts supplied with each pole product. The use of anchor bolts outside to those provided by Lumenpulse can alter the EPA and compromise the stability of a pole's installation. The nuts of each anchor bolt must be tightened to the listed torque requirement.

Template

An Anchor Bolt Template is included with each set of five poles. This template is needed to install anchor bolts that will coincide with the pole base layout. The template must be removed prior to pole installation. Special attention must be paid when using the template so as to account for the orientation of the pole's access door.

Anchor Bolt Projection

An anchor bolt's overall projection is an important consideration when securing a pole. Anchor bolts with a short projection can leave insufficient space to properly secure the pole base. An anchor bolt with too much projection can cause bending stress and can prevent the proper installation of the base cover.

Bolt Circle Diameter

The position of the bolt cut-outs on the lazer-cut template need to be confirmed before pouring concrete. This is to ensure that the template coincides with the pole base layout.

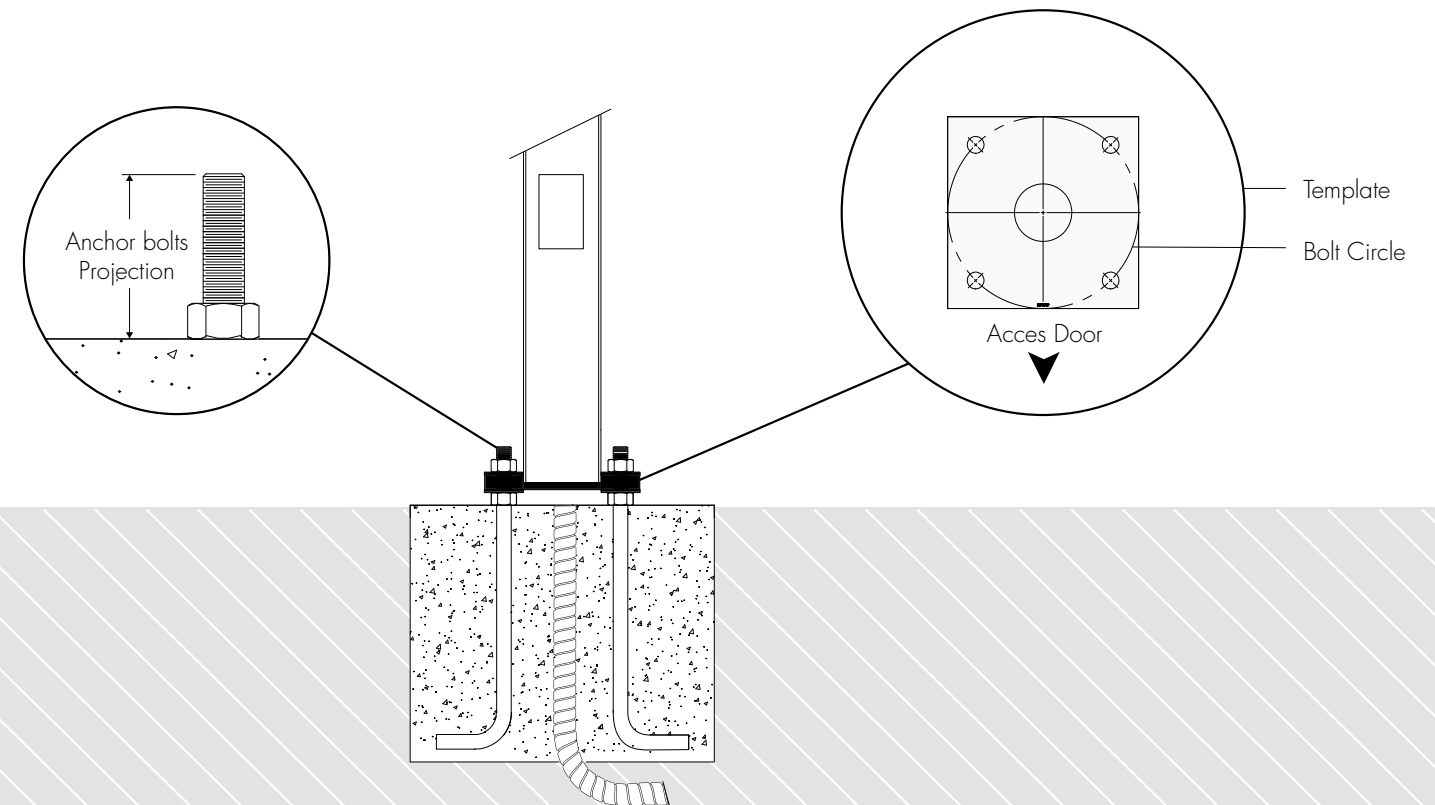

How to Calculate EPA

The geographic location of the project will determine your maximum EPA. To determine your maximum EPA, please consult the American Association of State Highway Transportation Officials (AASHTO) or the Canadian Standards Association (CSA) Wind-Pressure Tables and Wind Map to help find the maximum EPA in the United States or Canada.

Calculate the EPA for each combination of luminaire, pole, decorative arm, and accessory using the method shown (the EPA of all our products can also be found in the product's specification sheet).

Correlate each pole's dimensions (height, material, shape, and thickness) with the acceptable EPA accordingly to the AASHTO Wind Map.

Factors That Influence Maximum EPA Load

Dimensions: Available in 4, 5, 6, and 8 in diameters (maximum height can vary).

Shapes: Available in round, square, and fluted.

1 Find the total EPA of your luminaire with all the components such as decorative arm, banners, flowerpots, cameras, etc.

Type	Model	Qts.	EPA	Weight	Total EPA	Total Weight
Luminaire	LIAM	2	0.43 sq. ft.	32 lbs	0.86 sq. ft.	64 lbs
Decorative Arm	PU4-S2E	1	5.08 sq. ft.	28 lbs	5.08 sq. ft.	28 lbs
Accessories	Banner Arms	2	0.11 sq. ft.	4.13 lbs	0.22 sq. ft.	8.26 lbs
Others	18"x36" Banner (by others)	1	5.40 sq. ft.	TBD	5.40 sq. ft.	TBD
Total:					11.56 sq ft	100.26 lbs

*Banner Weight must be added.

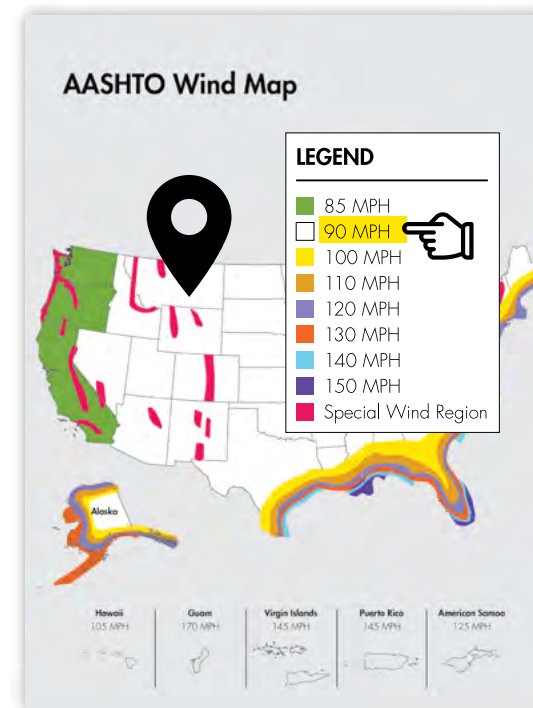

STRAIGHT POLE EPA RATING TABLE - AASHTO

Dimension (in)	Height (ft)	Wall Thickness (in)	EPA Rating	
			90 MPH	110 MPH
6"	10'	L - 1/8"	14.30	9.11
6"	11'	L - 1/8"	12.63	7.94
6"	12'	L - 1/8"	11.17	6.91
6"	13'	L - 1/8"	9.88	5.99
6"	14'	L - 1/8"	8.73	5.17
6"	15'	L - 1/8"	7.68	4.42
6"	16'	L - 1/8"	6.73	3.73
6"	17'	L - 1/8"	5.85	3.09
6"	18'	L - 1/8"	5.04	2.50
6"	19'	L - 1/8"	4.28	
6"	20'	L - 1/8"	3.56	
6"	21'	L - 1/8"	2.89	
6"	22'	L - 1/8"	2.25	
6"	10'	M - 3/16"	21.92	14.21
6"	11'	M - 3/16"	19.61	12.61
6"	12'	M - 3/16"	17.62	11.23
6"	13'	M - 3/16"	15.87	10.00
6"	14'	M - 3/16"	14.32	8.91
6"	15'	M - 3/16"	12.92	7.93
6"	16'	M - 3/16"	11.66	7.03
6"	17'	M - 3/16"	10.51	6.21

2 Select your location on the AASHTO Wind Map and find the right PA.

3 Round up the Location PA Data and confirm your choice of pole with the EPA Table Pages. Compare your results depending on height, thickness, or material.

*This guide is intended as a reference only. Please consult a qualified engineer.

Luminaire EPA Tables

			S40/S60	M80/M100	L120/L140
 Lumenblade Small	EPA	Without Motion Detector	0.59 sq. ft.	0.88 sq. ft.	1.25 sq. ft.
		With Motion Detector	0.79 sq. ft.	1.07 sq. ft.	1.45 sq. ft.
	Weight	Without Motion Detector	10 lbs	12.5 lbs	15 lbs
		With Motion Detector	12 lbs	14.5 lbs	17 lbs

			S40/S60	M80/M100	L120/L140/L160	XL180/XL200
 Lumenblade Medium	EPA	Without Motion Detector	0.69 sq. ft.	1.03 sq. ft.	1.46 sq. ft.	1.90 sq. ft.
		With Motion Detector	1.84 sq. ft.	2.5 sq. ft.	3.38 sq. ft.	4.26 sq. ft.
	Weight	Without Motion Detector	12.5 lbs	16 lbs	21 lbs	25 lbs
		With Motion Detector	15 lbs	18.5 lbs	23.5 lbs	27.5 lbs

 Lumenicon Medium	EPA	0.43 sq. ft.
	Weight	32 lbs

		S12 Adaptor (luminaire only)	PU1-S1X (4R&5R)*	PU1-S1E (4R&5R)*	PU1-S2E (4R&5R)*	PU3-S1E*
 Pure 100	EPA	0.43 sq. ft.	0.86 sq. ft.	1.16 sq. ft.	1.46 sq. ft.	1.35 sq. ft.
	Weight	30 lbs	33.5 lbs	37.3 lbs	71 lbs	43 lbs

		Pure T	Pure V	Pure Y
 Pure T-V-Y	EPA	Up to 1.33 sq. ft.	Up to 1.37 sq. ft.	Up to 1.31 sq. ft.
	Weight	Up to 40 lbs	Up to 40 lbs	Up to 40.5 lbs

		Small	Medium
 Allegra	EPA	0.5 sq. ft.	0.5 sq. ft.
	Weight	Up to 14 lbs	Up to 14 lbs

 Prestigia	EPA	2.57 sq. ft.
	Weight	41 lbs

 Classica	EPA	3.06 sq. ft.
	Weight	45 lbs

 Steele	EPA	1.19 sq. ft.
	Weight	60 lbs

		LBS	LBM	LBL	LBG	LBX
 Lumenbeam	EPA**	Up to 0.19 sq. ft.	Up to 0.44 sq. ft.	Up to 0.64 sq. ft.	Up to 1.12 sq. ft.	Up to 1.93 sq. ft.
	Weight	5.2 lbs	6.7 lbs	12 lbs	24 lbs	38 lbs

		LQL	LQG
 Lumenquad	EPA*	Up to 0.84 sq. ft.	Up to 1.34 sq. ft.
	Weight	15 lbs	23 lbs











*Luminaire included

**For EPA calculations regarding luminaires with accessories (snoots, visors, etc), please refer to specification sheets.





Decorative Arm and Banner Arm EPA Tables

ARM-P Decorative Arms for Pendant-Mount Luminaire



P3 - Pendant Small (3 bolts)					
Arm Style	Arm Configurations				
		W1X 	S1X 	S1E 	S2E 
CM0	EPA	0.81 sq. ft.	N/A		
	Weight	5.23 lbs			
DM0	EPA	0.73 sq. ft.	N/A		
	Weight	5.63 lbs			
DT6	EPA	0.52 sq. ft.	0.52 sq. ft.	0.51 sq. ft.	1.03 sq. ft.
	Weight	5.1 lbs	5.1 lbs	8.1 lbs	12.1 lbs
CS2	EPA	1.8 sq. ft.	1.8 sq. ft.	2.87 sq. ft.	4.9 sq. ft.
	Weight	7.39 lbs	7.39 lbs	21.04 lbs	31.65 lbs
CS4	EPA	0.87 sq. ft.	0.87 sq. ft.	1.08 sq. ft.	1.97 sq. ft.
	Weight	9.03 lbs	9.03 lbs	14.88 lbs	23.36 lbs
CS6	EPA	N/A	N/A	0.93 sq. ft.	1.43 sq. ft.
	Weight			16.23 lbs	25.88 lbs
CS12	EPA	0.43 sq. ft.	0.43 sq. ft.	1.61 sq. ft.	2.08 sq. ft.
	Weight	8.44 lbs	8.44 lbs	35.2 lbs	43.04 lbs
CS13	EPA	0.69 sq. ft.	0.69 sq. ft.	1.98 sq. ft.	2.23 sq. ft.
	Weight	10 lbs	10 lbs	16 lbs	23 lbs
MC5	EPA	1.84 sq. ft.	1.84 sq. ft.	2.07 sq. ft.	3.23 sq. ft.
	Weight	15.2 lbs	15.2 lbs	16.25 lbs	27.13 lbs







P4 - Pendant Medium (4 bolts)					
Arm Style	Arm Configurations				
		W1X 	S1X 	S1E 	S2E 
DT6	EPA	1.12 sq. ft.	1.12 sq. ft.	1.13 sq. ft.	2.10 sq. ft.
	Weight	5.1 lbs	5.1 lbs	8.1 lbs	12.1 lbs
CS2	EPA	1.83 sq. ft.	1.83 sq. ft.	3.02 sq. ft.	6.04 sq. ft.
	Weight	7.39 lbs	7.39 lbs	21.04 lbs	31.65 lbs
CS4	EPA	1.33 sq. ft.	1.33 sq. ft.	2.11 sq. ft.	3.53 sq. ft.
	Weight	9.03 lbs	9.03 lbs	14.88 lbs	23.36 lbs
CS6	EPA	N/A	N/A	1.52 sq. ft.	2.79 sq. ft.
	Weight			16.23 lbs	25.88 lbs
CS12	EPA	0.38 sq. ft.	0.38 sq. ft.	1.95 sq. ft.	2.39 sq. ft.
	Weight	5.17 lbs	5.17 lbs	35.2 lbs	43.04 lbs
CS13	EPA	1.05 sq. ft.	1.05 sq. ft.	1.84 sq. ft.	2.81 sq. ft.
	Weight	11 lbs	11 lbs	16 lbs	23 lbs
MC5	EPA	1.84 sq. ft.	1.84 sq. ft.	1.84 sq. ft.	3.68 sq. ft.
	Weight	15.2 lbs	15.2 lbs	16.25 lbs	27.13 lbs

ARM-T - Decorative Arms for Post-Top Mount Luminaire



TN3 - Tenon 3in and TN4 - Tenon 4in					
Arm Style	Arm Configurations				
		W1X 	S1X 	S1E 	S2E 
DT1	EPA	1.21 sq. ft.	1.21 sq. ft.	1.42 sq. ft.	2.42 sq. ft.
	Weight	8.88 lbs	8.88 lbs	14.32 lbs	19.28 lbs
DT6	EPA	1.12 sq. ft.	1.12 sq. ft.	1.13 sq. ft.	2.10 sq. ft.
	Weight	5.1 lbs	5.1 lbs	8.1 lbs	12.1 lbs
MC1	EPA	0.70 sq. ft.	0.70 sq. ft.	1.77 sq. ft.	2.57 sq. ft.
	Weight	8.20 lbs	8.20 lbs	16.95 lbs	24.20 lbs

ARM-S - Decorative Arms for Side-Mount Luminaire

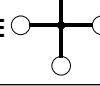
S12 - Side Internal 2-3/8in and SO2 - Side Overlap 2-3/8in			
Arm Style	Arm Configurations		
		SML 	LRG 
PU2	EPA	1.08 sq. ft.	1.67 sq. ft.
	Weight	12.09 lbs	14.87 lbs

Arm Style	Arm Configurations							
		W1X 	S1X 	S1E 	S2E 	S3E 	S3Y 	S4E 
PU4	EPA	N/A			3.13 sq. ft.	5.08 sq. ft.	N/A	
	Weight	N/A			24 lbs	28 lbs		
PU5	EPA	N/A			2.17 sq. ft.	2.88 sq. ft.	N/A	
	Weight	N/A			12.57 lbs	18 lbs		
PU8	EPA	0.19 sq. ft.	0.19 sq. ft.	0.42 sq. ft.	0.65 sq. ft.	0.86 sq. ft.	0.75 sq. ft.	1.08 sq. ft.
	Weight	2.2 lbs	2.2 lbs	6.52 lbs	8.09 lbs	9 lbs	9 lbs	9.9 lbs
CS12	EPA	0.38 sq. ft.	0.38 sq. ft.	1.95 sq. ft.	2.39 sq. ft.	N/A		
	Weight	5.17 lbs	5.17 lbs	35.2 lbs	43.04 lbs			
CS13	EPA	1.05 sq. ft.	1.05 sq. ft.	1.84 sq. ft.	2.81 sq. ft.	N/A		
	Weight	11 lbs	11 lbs	16 lbs	23 lbs			

BANNER ARM EPA

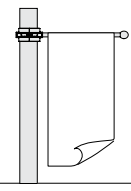
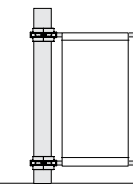
Banner Arm EPA			Banner (by others) EPA*	
Configuration	Banner Arm EPA		One Banner Arm (top only)	Two Banners Arms (top and bottom)
	Single  LR41, LR51, LRTR-5, LRTR-6, LRTR-8, LR5	Double  LR42, LR52		
EPA	0.11 sq. ft.	0.22 sq. ft.	1.80 sq. ft.	3.60 sq. ft.
Weight	4.13 lbs	7.03 lbs	2.70 sq. ft.	5.40 sq. ft.
			3.60 sq. ft.	7.20 sq. ft.

*Banner EPA for LR41 and LR52 configurations only.
Consult factory for other Banner Arms dimensions and Basket holder accessory EPA.

AASHTO Wind Map

The recommendations in this guide are meant to assist you with your projects. All pole installations need to be verified by a qualified engineer.

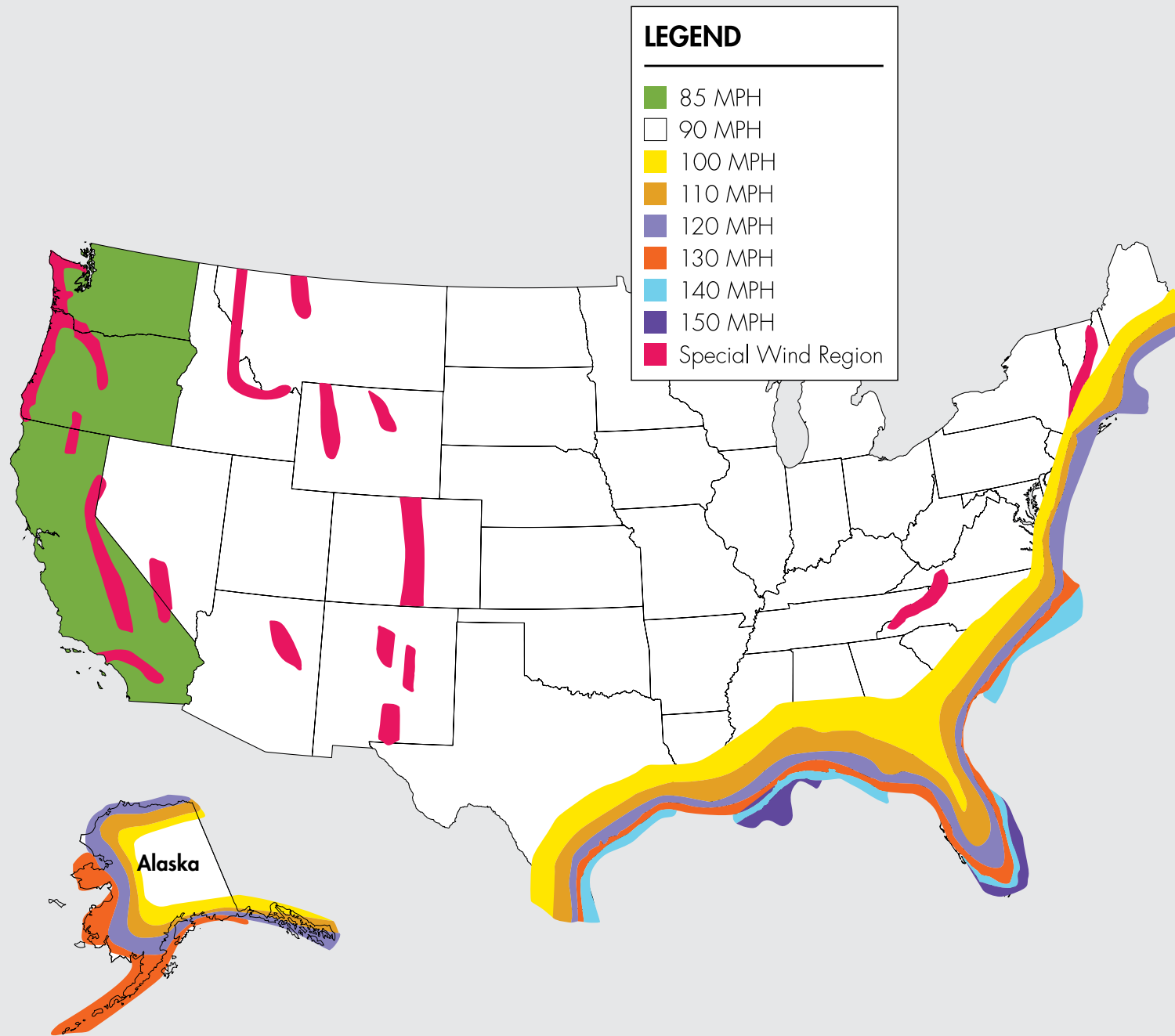

The AASHTO Wind Map is needed to determine the wind velocity for your specific region. Wind speed values are based on peak mean hourly wind speeds for a 50 year return period, 32.8 feet above the ground. This is stated in the AASHTO Standards Specifications for Structural Supports for Highway Signs, Luminaires, and Traffic signals.

When using this map, caution is advised in using the wind velocity contours in special wind areas such as mountain, great lakes, and coastal regions. If you are located between two different velocity isotach lines, the higher velocity should be used. This map is intended as a general guide and more localized analysis may be required. Please consult factory and a qualified engineer.

All of Lumenpulse's fixtures and arms have an EPA value (Effective Projected Area) which is defined as the maximum two dimensional area multiplied by the drag coefficient (Cd) designated by AASHTO. The sum of the fixture, arm, and accessories EPA must not exceed the maximum allowable pole EPA at the selected design wind speed.

Hawaii
105 MPH



Guam
170 MPH



Virgin Islands
145 MPH



Puerto Rico
145 MPH



American Samoa
125 MPH





STRAIGHT POLE

TECHNICAL INFORMATION

Straight Pole

Technical Information

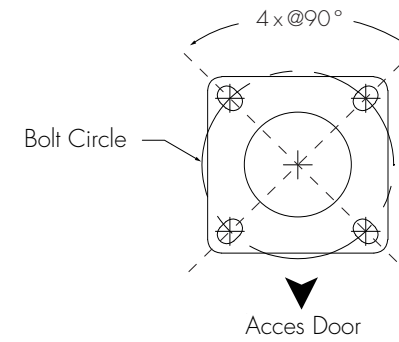
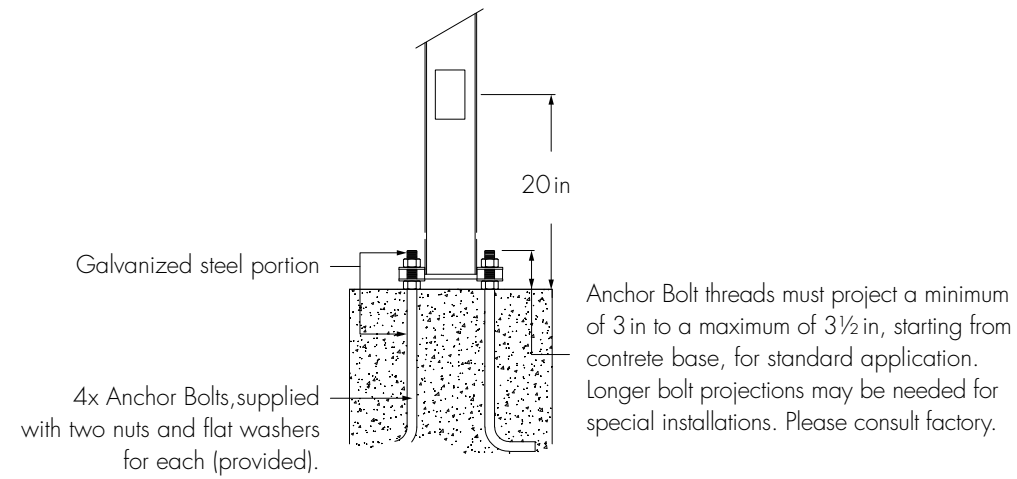

		Round Shapes		
		4 in	5 in	6 in
Wall Thickness*	Aluminium	L - M - H - W	L - M - H - W	L - M - H
	Steel	L - M - H - W	L - M - H - W	L - M - H - W
Maximum Height	Aluminium	Up to 20ft		Up to 30ft
	Steel	Up to 20ft	Up to 30ft	
Compatible Base Cover Options	Up to 20ft	P, WA, WB, WC, WF, WH, WI, WJ, WL, WM, WO, WP, WR, WS, WY, WYX	P, WA, WC, WF, WH, WI, WJ, WL, WM, WO, WP, WR, WS, WY, WYX	P, WC, WI, WL, WO, WY, WYX
	21 ft to 30ft	N/A	P, WF, WH, WI, WL, WM, WO, WR, WS, WYX	P, WO
Compatible Accessories		LR41, LR42 LH41, LH42	LR51, LR52	N/A
Anchor Bolts	Up to 20ft	Ø3/4 in x 26 in		
	21 ft to 30ft	Ø1 in x 36 in		
Bolt Circle	Up to 20ft	Ø8.5 in	Ø10 in	
	21 ft to 30ft	N/A	Ø11.5 in	Ø14 in

Square Shapes			Fluted Shapes	
4 in	5 in	6 in	4 in	5 in
L - M - H	L - M - H	L - M - H	M	M
L - M - W	L - M - H - W	M - H	N/A	N/A
Up to 20ft			Up to 20ft	
Up to 24ft	Up to 30ft		N/A	
P			P, WA, WB, WC, WF, WH, WI, WJ, WL, WM, WO, WP, WR, WS, WY, WYX	P, WA, WC, WF, WH, WI, WJ, WL, WM, WO, WP, WR, WS, WY, WYX
N/A			N/A	
N/A			LR41, LR42 LH41, LH42	LR51, LR52
Ø3/4 in x 26 in			Ø3/4 in x 26 in	
Ø1 in x 36 in			Ø1 in x 36 in	
Ø8.5 in	Ø10 in	Ø11.5 in	Ø8.5 in	Ø10 in
Ø10 in	Ø11.5 in	Ø14 in	N/A	

*For maximum wall thickness and height limitations, please consult the Straight Pole EPA Rating Table.

Straight Pole

Technical Information

Base Cover Options

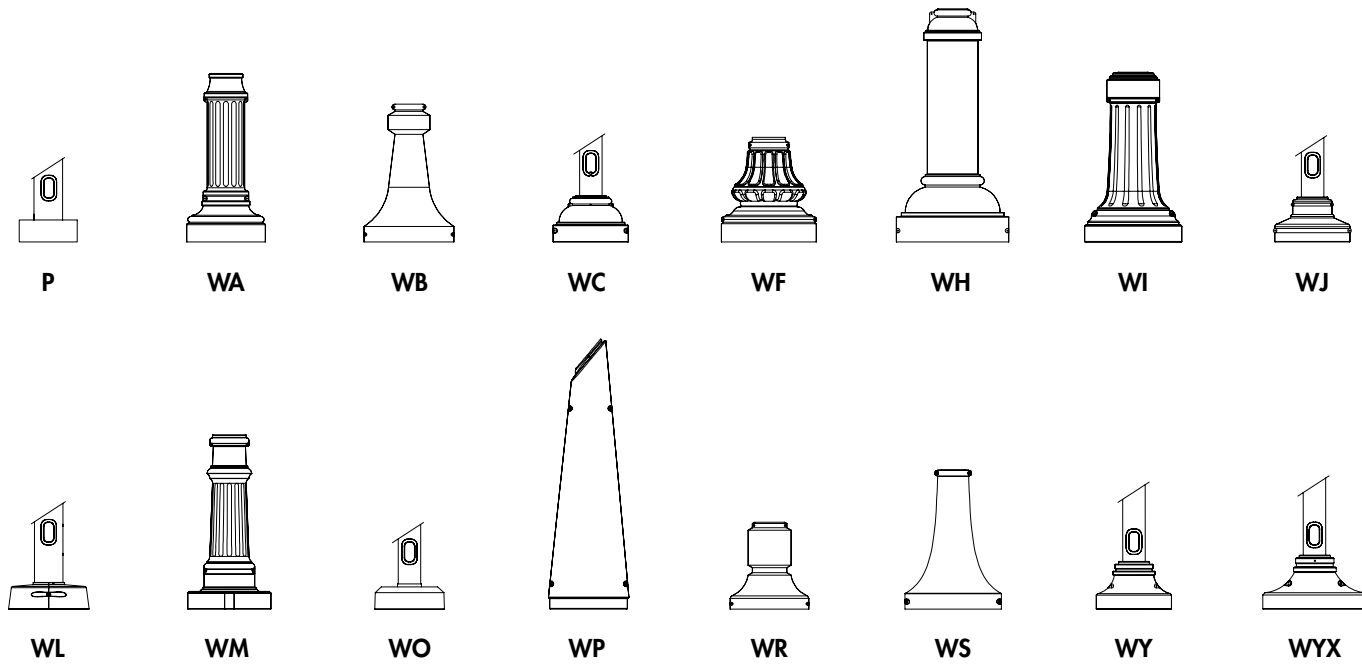

Banner Arm Accessories

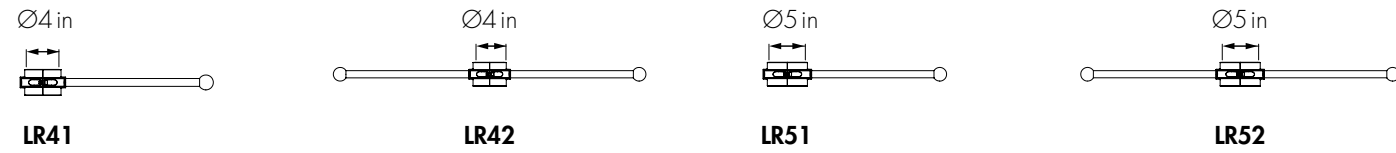

Basket Holder Accessories

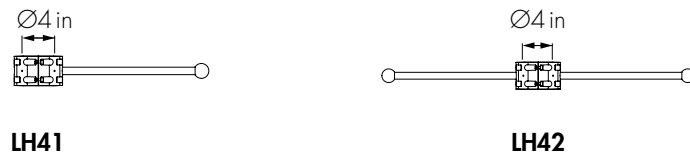

Pole-Top Options

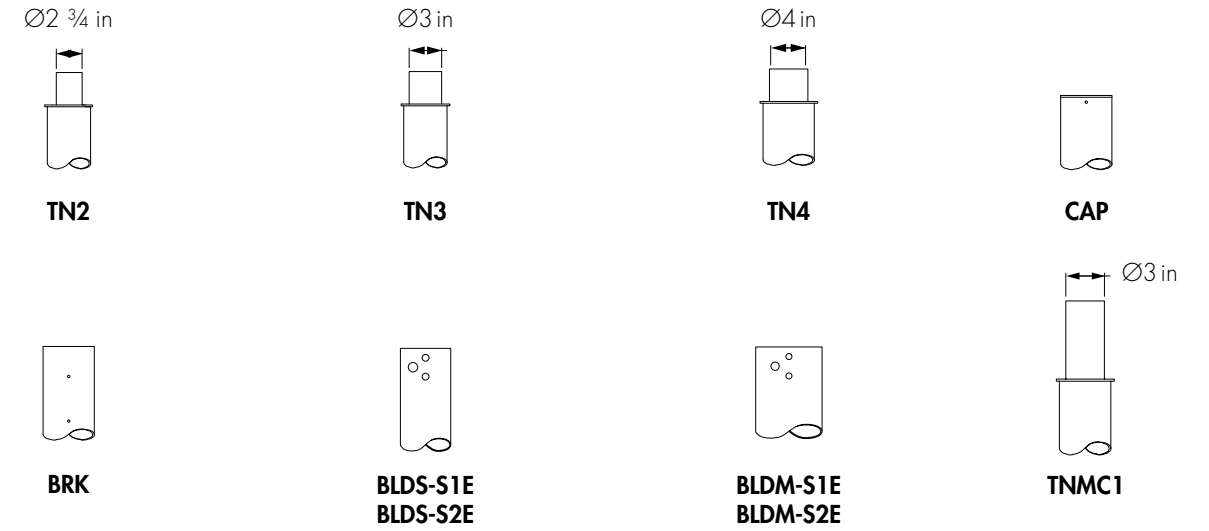

Other Options

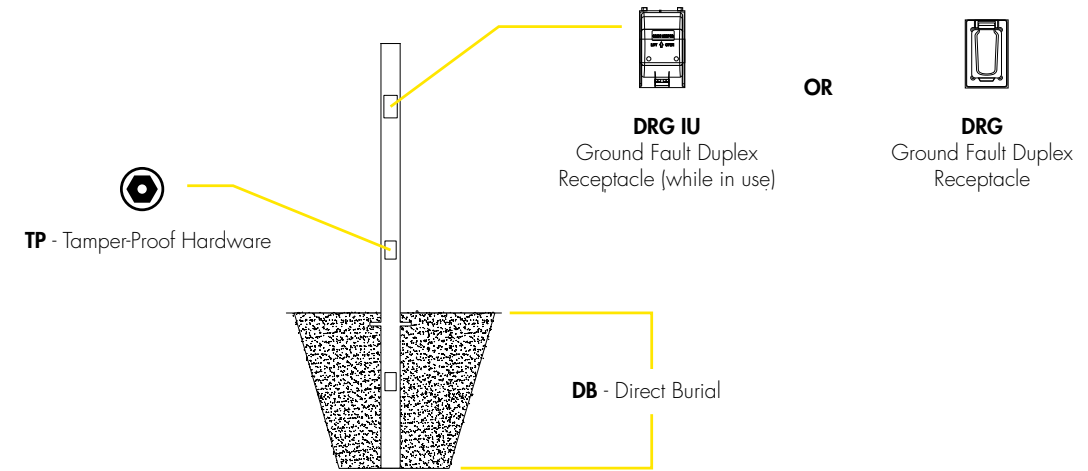

Finish Options



[1] Automatically included when a steel pole is specified.
 [2] Only available for steel poles with textured finish (immersion marks may occur).

STRAIGHT POLE
EPA RATING TABLE - AASHTO

**Aluminium
Round Shape**

Dimension (in)	Height (ft)	Wall Thickness (in)	EPA Rating (sq.ft.)				Anchor Bolts (in)	Bolt Circle (in)
			90MPH	110MPH	120MPH	150MPH		
4"	10'	L-1/8"	5.57	3.18	2.41		Ø¾" x 26"	Ø8½"
4"	11'	L-1/8"	4.79	2.59			Ø¾" x 26"	Ø8½"
4"	12'	L-1/8"	4.09	2.07			Ø¾" x 26"	Ø8½"
4"	13'	L-1/8"	3.47				Ø¾" x 26"	Ø8½"
4"	14'	L-1/8"	2.91				Ø¾" x 26"	Ø8½"
4"	15'	L-1/8"	2.40				Ø¾" x 26"	Ø8½"

4"	10'	M-3/16"	8.69	5.26	4.16	2.11	Ø¾" x 26"	Ø8½"
4"	11'	M-3/16"	7.64	4.50	3.49		Ø¾" x 26"	Ø8½"
4"	12'	M-3/16"	6.73	3.83	2.90		Ø¾" x 26"	Ø8½"
4"	13'	M-3/16"	5.92	3.23	2.36		Ø¾" x 26"	Ø8½"
4"	14'	M-3/16"	5.20	2.69			Ø¾" x 26"	Ø8½"
4"	15'	M-3/16"	4.54	2.19			Ø¾" x 26"	Ø8½"
4"	16'	M-3/16"	3.94				Ø¾" x 26"	Ø8½"
4"	17'	M-3/16"	3.38				Ø¾" x 26"	Ø8½"
4"	18'	M-3/16"	2.87				Ø¾" x 26"	Ø8½"
4"	19'	M-3/16"	2.38				Ø¾" x 26"	Ø8½"

4"	10'	H-¼"	11.49	7.14	5.74	3.12	Ø¾" x 26"	Ø8½"
4"	11'	H-¼"	10.22	6.23	4.94	2.55	Ø¾" x 26"	Ø8½"
4"	12'	H-¼"	9.11	5.42	4.23	2.04	Ø¾" x 26"	Ø8½"
4"	13'	H-¼"	8.13	4.71	3.60		Ø¾" x 26"	Ø8½"
4"	14'	H-¼"	7.26	4.07	3.03		Ø¾" x 26"	Ø8½"
4"	15'	H-¼"	6.47	3.48	2.51		Ø¾" x 26"	Ø8½"
4"	16'	H-¼"	5.76	2.94	2.03		Ø¾" x 26"	Ø8½"
4"	17'	H-¼"	5.10	2.44			Ø¾" x 26"	Ø8½"
4"	18'	H-¼"	4.49				Ø¾" x 26"	Ø8½"
4"	19'	H-¼"	3.93				Ø¾" x 26"	Ø8½"
4"	20'	H-¼"	3.40				Ø¾" x 26"	Ø8½"

4"	10'	W-5/16"	14.03	8.84	7.16	4.03	Ø¾" x 26"	Ø8½"
4"	11'	W-5/16"	12.54	7.78	6.24	3.39	Ø¾" x 26"	Ø8½"
4"	12'	W-5/16"	11.25	6.86	5.44	2.81	Ø¾" x 26"	Ø8½"
4"	13'	W-5/16"	10.12	6.04	4.72	2.29	Ø¾" x 26"	Ø8½"
4"	14'	W-5/16"	9.11	5.31	4.08		Ø¾" x 26"	Ø8½"
4"	15'	W-5/16"	8.21	4.64	3.49		Ø¾" x 26"	Ø8½"
4"	16'	W-5/16"	7.39	4.04	2.95		Ø¾" x 26"	Ø8½"
4"	17'	W-5/16"	6.65	3.48	2.45		Ø¾" x 26"	Ø8½"
4"	18'	W-5/16"	5.96	2.96			Ø¾" x 26"	Ø8½"
4"	19'	W-5/16"	5.32	2.47			Ø¾" x 26"	Ø8½"
4"	20'	W-5/16"	4.73	2.01			Ø¾" x 26"	Ø8½"

Consult factory for internal reinforcement solutions for higher EPA ratings.

STRAIGHT POLE
EPA RATING TABLE - AASHTO

**Aluminium
Round Shape**

Dimension (in)	Height (ft)	Wall Thickness (in)	EPA Rating (sq.ft.)				Anchor Bolts (in)	Bolt Circle (in)
			90MPH	110MPH	120MPH	150MPH		
5"	10'	L-1/8"	9.44	5.63	4.46	2.64	Ø¾" x 26"	Ø10"
5"	11'	L-1/8"	8.25	4.76	3.70	2.13	Ø¾" x 26"	Ø10"
5"	12'	L-1/8"	7.21	3.99	3.02		Ø¾" x 26"	Ø10"
5"	13'	L-1/8"	6.29	3.29	2.41		Ø¾" x 26"	Ø10"
5"	14'	L-1/8"	5.45	2.66			Ø¾" x 26"	Ø10"
5"	15'	L-1/8"	4.70	2.08			Ø¾" x 26"	Ø10"
5"	16'	L-1/8"	4.00				Ø¾" x 26"	Ø10"
5"	17'	L-1/8"	3.36				Ø¾" x 26"	Ø10"
5"	18'	L-1/8"	2.76				Ø¾" x 26"	Ø10"
5"	19'	L-1/8"	2.20				Ø¾" x 26"	Ø10"

5"	10'	M-3/16"	14.56	9.06	7.34	4.48	Ø¾" x 26"	Ø10"
5"	11'	M-3/16"	12.95	7.90	6.34	3.82	Ø¾" x 26"	Ø10"
5"	12'	M-3/16"	11.54	6.89	5.46	3.23	Ø¾" x 26"	Ø10"
5"	13'	M-3/16"	10.31	5.99	4.67	2.70	Ø¾" x 26"	Ø10"
5"	14'	M-3/16"	9.21	5.18	3.96	2.22	Ø¾" x 26"	Ø10"
5"	15'	M-3/16"	8.22	4.44	3.31		Ø¾" x 26"	Ø10"
5"	16'	M-3/16"	7.32	3.76	2.71		Ø¾" x 26"	Ø10"
5"	17'	M-3/16"	6.49	3.13	2.15		Ø¾" x 26"	Ø10"
5"	18'	M-3/16"	5.73	2.54			Ø¾" x 26"	Ø10"
5"	19'	M-3/16"	5.02				Ø¾" x 26"	Ø10"
5"	20'	M-3/16"	4.35				Ø¾" x 26"	Ø10"

5"	10'	H-¼"	19.28	12.22	10.00	6.18	Ø¾" x 26"	Ø10"
5"	11'	H-¼"	17.27	10.80	8.77	5.37	Ø¾" x 26"	Ø10"
5"	12'	H-¼"	15.54	9.56	7.71	4.67	Ø¾" x 26"	Ø10"
5"	13'	H-¼"	14.02	8.47	6.76	4.04	Ø¾" x 26"	Ø10"
5"	14'	H-¼"	12.67	7.49	5.91	3.47	Ø¾" x 26"	Ø10"
5"	15'	H-¼"	11.46	6.61	5.14	2.95	Ø¾" x 26"	Ø10"
5"	16'	H-¼"	10.37	5.80	4.43	2.47	Ø¾" x 26"	Ø10"
5"	17'	H-¼"	9.37	5.06	3.78	2.03	Ø¾" x 26"	Ø10"
5"	18'	H-¼"	8.46	4.37	3.17		Ø¾" x 26"	Ø10"
5"	19'	H-¼"	7.61	3.73	2.60		Ø¾" x 26"	Ø10"
5"	20'	H-¼"	6.82	3.13	2.06		Ø¾" x 26"	Ø10"

5"	10'	W-5/16"	23.63	15.13	12.44	7.75	Ø¾" x 26"	Ø10"
5"	11'	W-5/16"	21.26	13.47	11.02	6.81	Ø¾" x 26"	Ø10"
5"	12'	W-5/16"	19.22	12.03	9.78	5.99	Ø¾" x 26"	Ø10"
5"	13'	W-5/16"	17.44	10.76	8.68	5.27	Ø¾" x 26"	Ø10"
5"	14'	W-5/16"	15.86	9.63	7.70	4.62	Ø¾" x 26"	Ø10"
5"	15'	W-5/16"	14.46	8.61	6.82	4.03	Ø¾" x 26"	Ø10"
5"	16'	W-5/16"	13.19	7.69	6.01	3.49	Ø¾" x 26"	Ø10"
5"	17'	W-5/16"	12.04	6.84	5.27	2.99	Ø¾" x 26"	Ø10"
5"	18'	W-5/16"	10.98	6.06	4.59	2.52	Ø¾" x 26"	Ø10"
5"	19'	W-5/16"	10.01	5.33	3.95	2.09	Ø¾" x 26"	Ø10"
5"	20'	W-5/16"	9.10	4.65	3.34		Ø¾" x 26"	Ø10"

Consult factory for internal reinforcement solutions for higher EPA ratings.

STRAIGHT POLE
EPA RATING TABLE - AASHTO

**Aluminium
Round Shape**

Dimension (in)	Height (ft)	Wall Thickness (in)	EPA Rating (sq.ft.)				Anchor Bolts (in)	Bolt Circle (in)
			90 MPH	110 MPH	120 MPH	150 MPH		
6"	10'	L - 1/8"	14.30	9.11	7.54	4.62	Ø¾" x 26"	Ø10"
6"	11'	L - 1/8"	12.63	7.94	6.54	3.96	Ø¾" x 26"	Ø10"
6"	12'	L - 1/8"	11.17	6.91	5.67	3.38	Ø¾" x 26"	Ø10"
6"	13'	L - 1/8"	9.88	5.99	4.89	2.85	Ø¾" x 26"	Ø10"
6"	14'	L - 1/8"	8.73	5.17	4.18	2.38	Ø¾" x 26"	Ø10"
6"	15'	L - 1/8"	7.68	4.42	3.54		Ø¾" x 26"	Ø10"
6"	16'	L - 1/8"	6.73	3.73	2.95		Ø¾" x 26"	Ø10"
6"	17'	L - 1/8"	5.85	3.09	2.40		Ø¾" x 26"	Ø10"
6"	18'	L - 1/8"	5.04	2.50			Ø¾" x 26"	Ø10"
6"	19'	L - 1/8"	4.28				Ø¾" x 26"	Ø10"
6"	20'	L - 1/8"	3.56				Ø¾" x 26"	Ø10"
6"	21'	L - 1/8"	2.89				Ø1" x 36"	Ø14"
6"	22'	L - 1/8"	2.25				Ø1" x 36"	Ø14"

6"	10'	M - 3/16"	21.92	14.21	11.83	7.36	Ø¾" x 26"	Ø10"
6"	11'	M - 3/16"	19.61	12.61	10.47	6.47	Ø¾" x 26"	Ø10"
6"	12'	M - 3/16"	17.62	11.23	9.29	5.70	Ø¾" x 26"	Ø10"
6"	13'	M - 3/16"	15.87	10.00	8.26	5.01	Ø¾" x 26"	Ø10"
6"	14'	M - 3/16"	14.32	8.91	7.33	4.39	Ø¾" x 26"	Ø10"
6"	15'	M - 3/16"	12.92	7.93	6.49	3.83	Ø¾" x 26"	Ø10"
6"	16'	M - 3/16"	11.66	7.03	5.72	3.32	Ø¾" x 26"	Ø10"
6"	17'	M - 3/16"	10.51	6.21	5.02	2.85	Ø¾" x 26"	Ø10"
6"	18'	M - 3/16"	9.45	5.45	4.37	2.41	Ø¾" x 26"	Ø10"
6"	19'	M - 3/16"	8.47	4.74	3.76		Ø¾" x 26"	Ø10"
6"	20'	M - 3/16"	7.55	4.08	3.19		Ø¾" x 26"	Ø10"
6"	21'	M - 3/16"	6.70	3.45	2.65		Ø1" x 36"	Ø14"
6"	22'	M - 3/16"	5.89	2.86	2.14		Ø1" x 36"	Ø14"
6"	23'	M - 3/16"	5.13	2.30			Ø1" x 36"	Ø14"
6"	24'	M - 3/16"	4.41				Ø1" x 36"	Ø14"
6"	25'	M - 3/16"	3.72				Ø1" x 36"	Ø14"
6"	26'	M - 3/16"	3.06				Ø1" x 36"	Ø14"
6"	27'	M - 3/16"	2.43				Ø1" x 36"	Ø14"

Consult factory for internal reinforcement solutions for higher EPA ratings.

STRAIGHT POLE
EPA RATING TABLE - AASHTO

**Aluminium
Round Shape**

Dimension (in)	Height (ft)	Wall Thickness (in)	EPA Rating (sq.ft.)				Anchor Bolts (in)	Bolt Circle (in)
			90 MPH	110 MPH	120 MPH	150 MPH		
6"	10'	H - ¼"	29.05	18.98	15.84	9.93	Ø¾" x 26"	Ø10"
6"	11'	H - ¼"	26.15	16.99	14.15	8.83	Ø¾" x 26"	Ø10"
6"	12'	H - ¼"	23.65	15.26	12.69	7.87	Ø¾" x 26"	Ø10"
6"	13'	H - ¼"	21.47	13.75	11.41	7.02	Ø¾" x 26"	Ø10"
6"	14'	H - ¼"	19.54	12.41	10.27	6.27	Ø¾" x 26"	Ø10"
6"	15'	H - ¼"	17.82	11.21	9.24	5.60	Ø¾" x 26"	Ø10"
6"	16'	H - ¼"	16.27	10.12	8.32	4.98	Ø¾" x 26"	Ø10"
6"	17'	H - ¼"	14.87	9.13	7.47	4.41	Ø¾" x 26"	Ø10"
6"	18'	H - ¼"	13.58	8.21	6.69	3.89	Ø¾" x 26"	Ø10"
6"	19'	H - ¼"	12.39	7.37	5.96	3.41	Ø¾" x 26"	Ø10"
6"	20'	H - ¼"	11.29	6.58	5.29	2.95	Ø¾" x 26"	Ø10"
6"	21'	H - ¼"	10.26	5.84	4.66	2.52	Ø1" x 36"	Ø14"
6"	22'	H - ¼"	9.30	5.15	4.06	2.12	Ø1" x 36"	Ø14"
6"	23'	H - ¼"	8.40	4.49	3.50		Ø1" x 36"	Ø14"
6"	24'	H - ¼"	7.55	3.87	2.96		Ø1" x 36"	Ø14"
6"	25'	H - ¼"	6.74	3.27	2.45		Ø1" x 36"	Ø14"
6"	26'	H - ¼"	5.97	2.71			Ø1" x 36"	Ø14"
6"	27'	H - ¼"	5.24	2.17			Ø1" x 36"	Ø14"
6"	28'	H - ¼"	4.53				Ø1" x 36"	Ø14"
6"	29'	H - ¼"	3.86				Ø1" x 36"	Ø14"
6"	30'	H - ¼"	3.21				Ø1" x 36"	Ø14"

Consult factory for internal reinforcement solutions for higher EPA ratings.

STRAIGHT POLE
EPA RATING TABLE - AASHTO

Steel
Round Shape

Dimension (in)	Height (ft)	Wall Thickness (in)	EPA Rating (sq.ft.)				Anchor Bolts (in)	Bolt Circle (in)
			90MPH	110MPH	120MPH	150MPH		
4"	10'	L-1/8"	15.03	9.60	7.85	4.56	Ø¾" x 26"	Ø8½"
4"	11'	L-1/8"	13.25	8.35	6.76	3.81	Ø¾" x 26"	Ø8½"
4"	12'	L-1/8"	11.74	7.28	5.84	3.16	Ø¾" x 26"	Ø8½"
4"	13'	L-1/8"	10.44	6.35	5.02	2.58	Ø¾" x 26"	Ø8½"
4"	14'	L-1/8"	9.30	5.52	4.30	2.05	Ø¾" x 26"	Ø8½"
4"	15'	L-1/8"	8.28	4.78	3.65		Ø¾" x 26"	Ø8½"
4"	16'	L-1/8"	7.37	4.11	3.06		Ø¾" x 26"	Ø8½"
4"	17'	L-1/8"	6.54	3.49	2.51		Ø¾" x 26"	Ø8½"
4"	18'	L-1/8"	5.77	2.92	2.00		Ø¾" x 26"	Ø8½"
4"	19'	L-1/8"	5.07	2.39			Ø¾" x 26"	Ø8½"
4"	20'	L-1/8"	4.41				Ø¾" x 26"	Ø8½"

4"	10'	M-3/16"	21.82	14.15	11.66	7.01	Ø¾" x 26"	Ø8½"
4"	11'	M-3/16"	19.38	12.46	10.21	6.02	Ø¾" x 26"	Ø8½"
4"	12'	M-3/16"	17.33	11.02	8.98	5.17	Ø¾" x 26"	Ø8½"
4"	13'	M-3/16"	15.57	9.78	7.91	4.42	Ø¾" x 26"	Ø8½"
4"	14'	M-3/16"	14.03	8.69	6.97	3.76	Ø¾" x 26"	Ø8½"
4"	15'	M-3/16"	12.68	7.73	6.12	3.16	Ø¾" x 26"	Ø8½"
4"	16'	M-3/16"	11.47	6.85	5.36	2.61	Ø¾" x 26"	Ø8½"
4"	17'	M-3/16"	10.37	6.06	4.66	2.11	Ø¾" x 26"	Ø8½"
4"	18'	M-3/16"	9.37	5.33	4.02		Ø¾" x 26"	Ø8½"
4"	19'	M-3/16"	8.45	4.65	3.43		Ø¾" x 26"	Ø8½"
4"	20'	M-3/16"	7.60	4.02	2.87		Ø¾" x 26"	Ø8½"

4"	10'	H-¼"	27.83	18.17	15.05	9.17	Ø¾" x 26"	Ø8½"
4"	11'	H-¼"	24.81	16.09	13.27	7.97	Ø¾" x 26"	Ø8½"
4"	12'	H-¼"	22.28	14.33	11.76	6.95	Ø¾" x 26"	Ø8½"
4"	13'	H-¼"	20.11	12.82	10.46	6.06	Ø¾" x 26"	Ø8½"
4"	14'	H-¼"	18.23	11.50	9.32	5.27	Ø¾" x 26"	Ø8½"
4"	15'	H-¼"	16.57	10.33	8.31	4.56	Ø¾" x 26"	Ø8½"
4"	16'	H-¼"	15.09	9.28	7.40	3.92	Ø¾" x 26"	Ø8½"
4"	17'	H-¼"	13.76	8.33	6.57	3.33	Ø¾" x 26"	Ø8½"
4"	18'	H-¼"	12.55	7.46	5.81	2.78	Ø¾" x 26"	Ø8½"
4"	19'	H-¼"	11.44	6.65	5.11	2.27	Ø¾" x 26"	Ø8½"
4"	20'	H-¼"	10.41	5.91	4.45		Ø¾" x 26"	Ø8½"

4"	10'	W-5/16"	32.97	21.61	17.93	11.02	Ø¾" x 26"	Ø8½"
4"	11'	W-5/16"	29.45	19.19	15.88	9.64	Ø¾" x 26"	Ø8½"
4"	12'	W-5/16"	26.50	17.16	14.14	8.47	Ø¾" x 26"	Ø8½"
4"	13'	W-5/16"	23.99	15.42	12.64	7.45	Ø¾" x 26"	Ø8½"
4"	14'	W-5/16"	21.80	13.89	11.34	6.56	Ø¾" x 26"	Ø8½"
4"	15'	W-5/16"	19.88	12.55	10.18	5.75	Ø¾" x 26"	Ø8½"
4"	16'	W-5/16"	18.18	11.35	9.14	5.03	Ø¾" x 26"	Ø8½"
4"	17'	W-5/16"	16.64	10.26	8.19	4.36	Ø¾" x 26"	Ø8½"
4"	18'	W-5/16"	15.25	9.27	7.33	3.75	Ø¾" x 26"	Ø8½"
4"	19'	W-5/16"	13.98	8.36	6.54	3.18	Ø¾" x 26"	Ø8½"
4"	20'	W-5/16"	12.81	7.51	5.80	2.65	Ø¾" x 26"	Ø8½"

STRAIGHT POLE
EPA RATING TABLE - AASHTO

Steel
Round Shape

Dimension (in)	Height (ft)	Wall Thickness (in)	EPA Rating (sq.ft.)				Anchor Bolts (in)	Bolt Circle (in)
			90MPH	110MPH	120MPH	150MPH		
5"	10'	L-1/8"	28.59	18.56	15.37	9.65	Ø¾" x 26"	Ø10"
5"	11'	L-1/8"	25.44	16.38	13.51	8.44	Ø¾" x 26"	Ø10"
5"	12'	L-1/8"	22.79	14.53	11.92	7.40	Ø¾" x 26"	Ø10"
5"	13'	L-1/8"	20.52	12.94	10.56	6.50	Ø¾" x 26"	Ø10"
5"	14'	L-1/8"	18.55	11.54	9.35	5.71	Ø¾" x 26"	Ø10"
5"	15'	L-1/8"	16.81	10.30	8.28	5.00	Ø¾" x 26"	Ø10"
5"	16'	L-1/8"	15.26	9.19	7.32	4.36	Ø¾" x 26"	Ø10"
5"	17'	L-1/8"	13.87	8.18	6.44	3.77	Ø¾" x 26"	Ø10"
5"	18'	L-1/8"	12.60	7.26	5.64	3.23	Ø¾" x 26"	Ø10"
5"	19'	L-1/8"	11.44	6.40	4.89	2.73	Ø¾" x 26"	Ø10"
5"	20'	L-1/8"	10.37	5.61	4.19	2.26	Ø¾" x 26"	Ø10"
5"	21'	L-1/8"	9.37	4.87	3.54		Ø1" x 36"	Ø11.5"
5"	22'	L-1/8"	8.44	4.17	2.93		Ø1" x 36"	Ø11.5"
5"	23'	L-1/8"	7.57	3.51	2.34		Ø1" x 36"	Ø11.5"
5"	24'	L-1/8"	6.74	2.88			Ø1" x 36"	Ø11.5"
5"	25'	L-1/8"	5.96	2.28			Ø1" x 36"	Ø11.5"
5"	26'	L-1/8"	5.22				Ø1" x 36"	Ø11.5"
5"	27'	L-1/8"	4.50				Ø1" x 36"	Ø11.5"
5"	28'	L-1/8"	3.82				Ø1" x 36"	Ø11.5"
5"	29'	L-1/8"	3.16				Ø1" x 36"	Ø11.5"
5"	30'	L-1/8"	2.53				Ø1" x 36"	Ø11.5"

5"	10'	M-3/16"	40.00	27.40	22.80	14.41	Ø¾" x 26"	Ø10"
5"	11'	M-3/16"	37.38	24.37	20.22	12.74	Ø¾" x 26"	Ø10"
5"	12'	M-3/16"	33.68	21.82	18.05	11.32	Ø¾" x 26"	Ø10"
5"	13'	M-3/16"	30.53	19.63	16.18	10.10	Ø¾" x 26"	Ø10"
5"	14'	M-3/16"	27.80	17.73	14.56	9.04	Ø¾" x 26"	Ø10"
5"	15'	M-3/16"	25.41	16.06	13.12	8.09	Ø¾" x 26"	Ø10"
5"	16'	M-3/16"	23.29	14.56	11.83	7.25	Ø¾" x 26"	Ø10"
5"	17'	M-3/16"	21.39	13.21	10.67	6.48	Ø¾" x 26"	Ø10"
5"	18'	M-3/16"	19.67	11.99	9.61	5.78	Ø¾" x 26"	Ø10"
5"	19'	M-3/16"	18.10	10.86	8.64	5.13	Ø¾" x 26"	Ø10"
5"	20'	M-3/16"	16.67	9.83	7.74	4.53	Ø¾" x 26"	Ø10"
5"	21'	M-3/16"	15.34	8.86	6.90	3.97	Ø1" x 36"	Ø11.5"
5"	22'	M-3/16"	14.11	7.96	6.11	3.44	Ø1" x 36"	Ø11.5"
5"	23'	M-3/16"	12.95	7.11	5.37	2.94	Ø1" x 36"	Ø11.5"
5"	24'	M-3/16"	11.87	6.31	4.67	2.47	Ø1" x 36"	Ø11.5"
5"	25'	M-3/16"	10.85	5.56	4.00	2.02	Ø1" x 36"	Ø11.5"
5"	26'	M-3/16"	9.88	4.83	3.36		Ø1" x 36"	Ø11.5"
5"	27'	M-3/16"	8.96	4.14	2.75		Ø1" x 36"	Ø11.5"
5"	28'	M-3/16"	8.08	3.48	2.16		Ø1" x 36"	Ø11.5"
5"	29'	M-3/16"	7.24	2.84			Ø1" x 36"	Ø11.5"
5"	30'	M-3/16"	6.43	2.22			Ø1" x 36"	Ø11.5"

Consult factory for reinforcement solutions for higher EPA ratings.

STRAIGHT POLE
EPA RATING TABLE - AASHTO

Steel
Round Shape

Dimension (in)	Height (ft)	Wall Thickness (in)	EPA Rating (sq.ft.)				Anchor Bolts (in)	Bolt Circle (in)
			90 MPH	110 MPH	120 MPH	150 MPH		
5"	10'	H - 1/4"	40.00	35.41	29.53	18.72	Ø3/4" x 26"	Ø10"
5"	11'	H - 1/4"	40.00	31.61	26.31	16.63	Ø3/4" x 26"	Ø10"
5"	12'	H - 1/4"	40.00	28.42	23.60	14.87	Ø3/4" x 26"	Ø10"
5"	13'	H - 1/4"	39.59	25.70	21.28	13.37	Ø3/4" x 26"	Ø10"
5"	14'	H - 1/4"	36.17	23.34	19.27	12.05	Ø3/4" x 26"	Ø10"
5"	15'	H - 1/4"	33.19	21.27	17.50	10.90	Ø3/4" x 26"	Ø10"
5"	16'	H - 1/4"	30.55	19.42	15.92	9.86	Ø3/4" x 26"	Ø10"
5"	17'	H - 1/4"	28.19	17.77	14.50	8.93	Ø3/4" x 26"	Ø10"
5"	18'	H - 1/4"	26.07	16.27	13.21	8.08	Ø3/4" x 26"	Ø10"
5"	19'	H - 1/4"	24.13	14.90	12.03	7.30	Ø3/4" x 26"	Ø10"
5"	20'	H - 1/4"	22.37	13.64	10.94	6.58	Ø3/4" x 26"	Ø10"
5"	21'	H - 1/4"	20.74	12.48	9.94	5.91	Ø1" x 36"	Ø11.5"
5"	22'	H - 1/4"	19.23	11.39	8.99	5.29	Ø1" x 36"	Ø11.5"
5"	23'	H - 1/4"	17.82	10.37	8.11	4.70	Ø1" x 36"	Ø11.5"
5"	24'	H - 1/4"	16.50	9.42	7.27	4.14	Ø1" x 36"	Ø11.5"
5"	25'	H - 1/4"	15.27	8.51	6.48	3.61	Ø1" x 36"	Ø11.5"
5"	26'	H - 1/4"	14.09	7.65	5.73	3.10	Ø1" x 36"	Ø11.5"
5"	27'	H - 1/4"	12.98	6.83	5.02	2.62	Ø1" x 36"	Ø11.5"
5"	28'	H - 1/4"	11.93	6.05	4.33	2.16	Ø1" x 36"	Ø11.5"
5"	29'	H - 1/4"	10.92	5.30	3.67		Ø1" x 36"	Ø11.5"
5"	30'	H - 1/4"	9.95	4.57	3.03		Ø1" x 36"	Ø11.5"

5"	10'	W - 5/16"	40.00	40.00	35.65	22.63	Ø3/4" x 26"	Ø10"
5"	11'	W - 5/16"	40.00	38.19	31.83	20.17	Ø3/4" x 26"	Ø10"
5"	12'	W - 5/16"	40.00	34.42	28.64	18.10	Ø3/4" x 26"	Ø10"
5"	13'	W - 5/16"	40.00	31.21	25.91	16.33	Ø3/4" x 26"	Ø10"
5"	14'	W - 5/16"	40.00	28.43	23.55	14.79	Ø3/4" x 26"	Ø10"
5"	15'	W - 5/16"	40.26	26.00	21.47	13.44	Ø3/4" x 26"	Ø10"
5"	16'	W - 5/16"	37.15	23.84	19.63	12.24	Ø3/4" x 26"	Ø10"
5"	17'	W - 5/16"	34.37	21.91	17.98	11.15	Ø3/4" x 26"	Ø10"
5"	18'	W - 5/16"	31.87	20.16	16.48	10.17	Ø3/4" x 26"	Ø10"
5"	19'	W - 5/16"	29.61	18.57	15.11	9.27	Ø3/4" x 26"	Ø10"
5"	20'	W - 5/16"	27.54	17.10	13.85	8.44	Ø3/4" x 26"	Ø10"
5"	21'	W - 5/16"	25.63	15.75	12.69	7.67	Ø1" x 36"	Ø11.5"
5"	22'	W - 5/16"	23.87	14.50	11.61	6.96	Ø1" x 36"	Ø11.5"
5"	23'	W - 5/16"	22.23	13.33	10.59	6.28	Ø1" x 36"	Ø11.5"
5"	24'	W - 5/16"	20.70	12.23	9.64	5.65	Ø1" x 36"	Ø11.5"
5"	25'	W - 5/16"	19.26	11.19	8.73	5.05	Ø1" x 36"	Ø11.5"
5"	26'	W - 5/16"	17.91	10.20	7.88	4.48	Ø1" x 36"	Ø11.5"
5"	27'	W - 5/16"	16.62	9.27	7.06	3.93	Ø1" x 36"	Ø11.5"
5"	28'	W - 5/16"	15.40	8.37	6.28	3.41	Ø1" x 36"	Ø11.5"
5"	29'	W - 5/16"	14.23	7.52	5.53	2.90	Ø1" x 36"	Ø11.5"
5"	30'	W - 5/16"	13.12	6.70	4.81	2.42	Ø1" x 36"	Ø11.5"

Consult factory for reinforcement solutions for higher EPA ratings.

STRAIGHT POLE
EPA RATING TABLE - AASHTO

Steel
Round Shape

Dimension (in)	Height (ft)	Wall Thickness (in)	EPA Rating (sq.ft.)				Anchor Bolts (in)	Bolt Circle (in)
			90 MPH	110 MPH	120 MPH	150 MPH		
6"	10'	L - 1/8"	26.51	17.35	14.49	9.10	Ø3/4" x 26"	Ø10"
6"	11'	L - 1/8"	23.49	15.28	12.73	7.95	Ø3/4" x 26"	Ø10"
6"	12'	L - 1/8"	20.94	13.52	11.25	6.98	Ø3/4" x 26"	Ø10"
6"	13'	L - 1/8"	18.75	12.01	9.96	6.13	Ø3/4" x 26"	Ø10"
6"	14'	L - 1/8"	16.84	10.68	8.83	5.39	Ø3/4" x 26"	Ø10"
6"	15'	L - 1/8"	15.16	9.50	7.83	4.72	Ø3/4" x 26"	Ø10"
6"	16'	L - 1/8"	13.65	8.44	6.92	4.12	Ø3/4" x 26"	Ø10"
6"	17'	L - 1/8"	12.28	7.47	6.10	3.57	Ø3/4" x 26"	Ø10"
6"	18'	L - 1/8"	11.04	6.59	5.34	3.07	Ø3/4" x 26"	Ø10"
6"	19'	L - 1/8"	9.89	5.77	4.64	2.60	Ø3/4" x 26"	Ø10"
6"	20'	L - 1/8"	8.83	5.01	3.99	2.16	Ø3/4" x 26"	Ø10"
6"	21'	L - 1/8"	7.85	4.30	3.38		Ø1" x 36"	Ø14"
6"	22'	L - 1/8"	6.92	3.63	2.81		Ø1" x 36"	Ø14"
6"	23'	L - 1/8"	6.05	2.99	2.26		Ø1" x 36"	Ø14"
6"	24'	L - 1/8"	5.22	2.39			Ø1" x 36"	Ø14"
6"	25'	L - 1/8"	4.44				Ø1" x 36"	Ø14"
6"	26'	L - 1/8"	3.69				Ø1" x 36"	Ø14"
6"	27'	L - 1/8"	2.97				Ø1" x 36"	Ø14"
6"	28'	L - 1/8"	2.28				Ø1" x 36"	Ø14"

6"	10'	M - 3/16"	40.43	26.68	22.32	14.11	Ø3/4" x 26"	Ø10"
6"	11'	M - 3/16"	36.08	23.71	19.82	12.49	Ø3/4" x 26"	Ø10"
6"	12'	M - 3/16"	32.43	21.21	17.71	11.11	Ø3/4" x 26"	Ø10"
6"	13'	M - 3/16"	29.31	19.07	15.90	9.93	Ø3/4" x 26"	Ø10"
6"	14'	M - 3/16"	26.60	17.21	14.32	8.90	Ø3/4" x 26"	Ø10"
6"	15'	M - 3/16"	24.23	15.57	12.93	7.99	Ø3/4" x 26"	Ø10"
6"	16'	M - 3/16"	22.12	14.11	11.69	7.17	Ø3/4" x 26"	Ø10"
6"	17'	M - 3/16"	20.23	12.79	10.57	6.43	Ø3/4" x 26"	Ø10"
6"	18'	M - 3/16"	18.51	11.59	9.55	5.76	Ø3/4" x 26"	Ø10"
6"	19'	M - 3/16"	16.95	10.49	8.61	5.13	Ø3/4" x 26"	Ø10"
6"	20'	M - 3/16"	15.51	9.48	7.75	4.56	Ø3/4" x 26"	Ø10"
6"	21'	M - 3/16"	14.17	8.53	6.94	4.02	Ø1" x 36"	Ø14"
6"	22'	M - 3/16"	12.93	7.65	6.19	3.51	Ø1" x 36"	Ø14"
6"	23'	M - 3/16"	11.77	6.82	5.48	3.04	Ø1" x 36"	Ø14"
6"	24'	M - 3/16"	10.68	6.04	4.81	2.59	Ø1" x 36"	Ø14"
6"	25'	M - 3/16"	9.65	5.30	4.17	2.16	Ø1" x 36"	Ø14"
6"	26'	M - 3/16"	8.67	4.59	3.57		Ø1" x 36"	Ø14"
6"	27'	M - 3/16"	7.74	3.92	2.99		Ø1" x 36"	Ø14"
6"	28'	M - 3/16"	6.85	3.27	2.43		Ø1" x 36"	Ø14"
6"	29'	M - 3/16"	5.99	2.65			Ø1" x 36"	Ø14"
6"	30'	M - 3/16"	5.17	2.05			Ø1" x 36"	Ø14"

Consult factory for reinforcement solutions for higher EPA ratings.

STRAIGHT POLE
EPA RATING TABLE - AASHTO

Steel
Round Shape

Dimension (in)	Height (ft)	Wall Thickness (in)	EPA Rating (sq.ft.)				Anchor Bolts (in)	Bolt Circle (in)
			90MPH	110MPH	120MPH	150MPH		
6"	10'	H - 1/4"	40.00	34.44	28.85	18.29	Ø3/4" x 26"	Ø10"
6"	11'	H - 1/4"	40.00	30.73	25.72	16.26	Ø3/4" x 26"	Ø10"
6"	12'	H - 1/4"	40.00	27.62	23.09	14.56	Ø3/4" x 26"	Ø10"
6"	13'	H - 1/4"	38.10	24.96	20.84	13.10	Ø3/4" x 26"	Ø10"
6"	14'	H - 1/4"	34.74	22.66	18.89	11.83	Ø3/4" x 26"	Ø10"
6"	15'	H - 1/4"	31.79	20.63	17.18	10.71	Ø3/4" x 26"	Ø10"
6"	16'	H - 1/4"	29.18	18.83	15.66	9.71	Ø3/4" x 26"	Ø10"
6"	17'	H - 1/4"	26.84	17.22	14.29	8.81	Ø3/4" x 26"	Ø10"
6"	18'	H - 1/4"	24.74	15.76	13.05	8.00	Ø3/4" x 26"	Ø10"
6"	19'	H - 1/4"	22.82	14.42	11.91	7.25	Ø3/4" x 26"	Ø10"
6"	20'	H - 1/4"	21.06	13.20	10.87	6.56	Ø3/4" x 26"	Ø10"
6"	21'	H - 1/4"	19.44	12.06	9.90	5.92	Ø1" x 36"	Ø14"
6"	22'	H - 1/4"	17.93	11.00	9.00	5.32	Ø1" x 36"	Ø14"
6"	23'	H - 1/4"	16.53	10.01	8.16	4.75	Ø1" x 36"	Ø14"
6"	24'	H - 1/4"	15.22	9.08	7.36	4.22	Ø1" x 36"	Ø14"
6"	25'	H - 1/4"	13.98	8.20	6.61	3.72	Ø1" x 36"	Ø14"
6"	26'	H - 1/4"	12.81	7.36	5.89	3.24	Ø1" x 36"	Ø14"
6"	27'	H - 1/4"	11.70	6.57	5.21	2.78	Ø1" x 36"	Ø14"
6"	28'	H - 1/4"	10.64	5.81	4.56	2.34	Ø1" x 36"	Ø14"
6"	29'	H - 1/4"	9.62	5.08	3.94		Ø1" x 36"	Ø14"
6"	30'	H - 1/4"	8.65	4.38	3.34		Ø1" x 36"	Ø14"

6"	10'	W - 5/16"	40.00	40.00	34.71	22.04	Ø3/4" x 26"	Ø10"
6"	11'	W - 5/16"	40.00	37.04	31.02	19.66	Ø3/4" x 26"	Ø10"
6"	12'	W - 5/16"	40.00	33.37	27.92	17.65	Ø3/4" x 26"	Ø10"
6"	13'	W - 5/16"	40.00	30.25	25.29	15.94	Ø3/4" x 26"	Ø10"
6"	14'	W - 5/16"	40.00	27.55	23.00	14.46	Ø3/4" x 26"	Ø10"
6"	15'	W - 5/16"	38.58	25.18	21.00	13.16	Ø3/4" x 26"	Ø10"
6"	16'	W - 5/16"	35.52	23.08	19.22	12.00	Ø3/4" x 26"	Ø10"
6"	17'	W - 5/16"	32.79	21.20	17.63	10.95	Ø3/4" x 26"	Ø10"
6"	18'	W - 5/16"	30.33	19.50	16.19	10.01	Ø3/4" x 26"	Ø10"
6"	19'	W - 5/16"	28.09	17.95	14.88	9.15	Ø3/4" x 26"	Ø10"
6"	20'	W - 5/16"	26.05	16.53	13.67	8.35	Ø3/4" x 26"	Ø10"
6"	21'	W - 5/16"	24.17	15.22	12.56	7.62	Ø1" x 36"	Ø14"
6"	22'	W - 5/16"	22.42	14.01	11.53	6.93	Ø1" x 36"	Ø14"
6"	23'	W - 5/16"	20.80	12.87	10.56	6.29	Ø1" x 36"	Ø14"
6"	24'	W - 5/16"	19.29	11.80	9.65	5.69	Ø1" x 36"	Ø14"
6"	25'	W - 5/16"	17.86	10.80	8.79	5.11	Ø1" x 36"	Ø14"
6"	26'	W - 5/16"	16.52	9.85	7.98	4.57	Ø1" x 36"	Ø14"
6"	27'	W - 5/16"	15.24	8.94	7.21	4.05	Ø1" x 36"	Ø14"
6"	28'	W - 5/16"	14.03	8.08	6.47	3.56	Ø1" x 36"	Ø14"
6"	29'	W - 5/16"	12.87	7.25	5.76	3.09	Ø1" x 36"	Ø14"
6"	30'	W - 5/16"	11.77	6.46	5.09	2.63	Ø1" x 36"	Ø14"

Consult factory for reinforcement solutions for higher EPA ratings.

STRAIGHT POLE
EPA RATING TABLE - AASHTO

Aluminium
Square Shape

Dimension (in)	Height (ft)	Wall Thickness (in)	EPA Rating (sq.ft.)				Anchor Bolts (in)	Bolt Circle (in)
			90MPH	110MPH	120MPH	150MPH		
4"	10'	L - 1/8"	4.30				Ø3/4" x 26"	Ø8 1/2"
4"	11'	L - 1/8"	3.14				Ø3/4" x 26"	Ø8 1/2"
4"	12'	L - 1/8"	2.08				Ø3/4" x 26"	Ø8 1/2"

4"	10'	M - 3/16"	8.38	4.27	2.93		Ø3/4" x 26"	Ø8 1/2"
4"	11'	M - 3/16"	6.86	3.10			Ø3/4" x 26"	Ø8 1/2"
4"	12'	M - 3/16"	5.51	2.05			Ø3/4" x 26"	Ø8 1/2"
4"	13'	M - 3/16"	4.29				Ø3/4" x 26"	Ø8 1/2"
4"	14'	M - 3/16"	3.17				Ø3/4" x 26"	Ø8 1/2"
4"	15'	M - 3/16"	2.14				Ø3/4" x 26"	Ø8 1/2"

4"	10'	H - 1/4"	11.73	6.51	4.82		Ø3/4" x 26"	Ø8 1/2"
4"	11'	H - 1/4"	9.92	5.15	3.61		Ø3/4" x 26"	Ø8 1/2"
4"	12'	H - 1/4"	8.33	3.93	2.51		Ø3/4" x 26"	Ø8 1/2"
4"	13'	H - 1/4"	6.89	2.83			Ø3/4" x 26"	Ø8 1/2"
4"	14'	H - 1/4"	5.60				Ø3/4" x 26"	Ø8 1/2"
4"	15'	H - 1/4"	4.40				Ø3/4" x 26"	Ø8 1/2"
4"	16'	H - 1/4"	3.30				Ø3/4" x 26"	Ø8 1/2"
4"	17'	H - 1/4"	2.27				Ø3/4" x 26"	Ø8 1/2"

5"	10'	L - 1/8"	7.97	3.65	2.26		Ø3/4" x 26"	Ø10"
5"	11'	L - 1/8"	6.29	2.35			Ø3/4" x 26"	Ø10"
5"	12'	L - 1/8"	4.79				Ø3/4" x 26"	Ø10"
5"	13'	L - 1/8"	3.42				Ø3/4" x 26"	Ø10"
5"	14'	L - 1/8"	2.16				Ø3/4" x 26"	Ø10"

5"	10'	M - 3/16"	14.29	7.88	5.81		Ø3/4" x 26"	Ø10"
5"	11'	M - 3/16"	12.07	6.21	4.32		Ø3/4" x 26"	Ø10"
5"	12'	M - 3/16"	10.10	4.71	2.97		Ø3/4" x 26"	Ø10"
5"	13'	M - 3/16"	8.34	3.35			Ø3/4" x 26"	Ø10"
5"	14'	M - 3/16"	6.74	2.09			Ø3/4" x 26"	Ø10"
5"	15'	M - 3/16"	5.27				Ø3/4" x 26"	Ø10"
5"	16'	M - 3/16"	3.91				Ø3/4" x 26"	Ø10"
5"	17'	M - 3/16"	2.64				Ø3/4" x 26"	Ø10"

5"	10'	H - 1/4"	19.33	11.26	8.65	3.70	Ø3/4" x 26"	Ø10"
5"	11'	H - 1/4"	16.68	9.30	6.91	2.39	Ø3/4" x 26"	Ø10"
5"	12'	H - 1/4"	14.35	7.55	5.36		Ø3/4" x 26"	Ø10"
5"	13'	H - 1/4"	12.27	5.98	3.95		Ø3/4" x 26"	Ø10"
5"	14'	H - 1/4"	10.40	4.54	2.65		Ø3/4" x 26"	Ø10"
5"	15'	H - 1/4"	8.70	3.22			Ø3/4" x 26"	Ø10"
5"	16'	H - 1/4"	7.13				Ø3/4" x 26"	Ø10"
5"	17'	H - 1/4"	5.67				Ø3/4" x 26"	Ø10"
5"	18'	H - 1/4"	4.31				Ø3/4" x 26"	Ø10"
5"	19'	H - 1/4"	3.03				Ø3/4" x 26"	Ø10"

Consult factory for internal reinforcement solutions for higher EPA ratings.

STRAIGHT POLE
EPA RATING TABLE - AASHTO

Aluminium
Square Shape

Dimension (in)	Height (ft)	Wall Thickness (in)	EPA Rating (sq.ft.)				Anchor Bolts (in)	Bolt Circle (in)
			90 MPH	110 MPH	120 MPH	150 MPH		
6"	10'	M - 3/16"	23.63	13.80	10.62	4.60	Ø¾" x 26"	Ø11.5"
6"	11'	M - 3/16"	20.42	11.43	8.52	3.02	Ø¾" x 26"	Ø11.5"
6"	12'	M - 3/16"	17.60	9.32	6.64		Ø¾" x 26"	Ø11.5"
6"	13'	M - 3/16"	15.08	7.42	4.94		Ø¾" x 26"	Ø11.5"
6"	14'	M - 3/16"	12.82	5.68	3.37		Ø¾" x 26"	Ø11.5"
6"	15'	M - 3/16"	10.75	4.08			Ø¾" x 26"	Ø11.5"
6"	16'	M - 3/16"	8.86	2.58			Ø¾" x 26"	Ø11.5"
6"	17'	M - 3/16"	7.09				Ø¾" x 26"	Ø11.5"
6"	18'	M - 3/16"	5.45				Ø¾" x 26"	Ø11.5"
6"	19'	M - 3/16"	3.90				Ø¾" x 26"	Ø11.5"
6"	20'	M - 3/16"	2.44				Ø¾" x 26"	Ø11.5"

Consult factory for reinforcement solutions for higher EPA ratings.

STRAIGHT POLE
EPA RATING TABLE - AASHTO

Steel
Square Shape

Dimension (in)	Height (ft)	Wall Thickness (in)	EPA Rating (sq.ft.)				Anchor Bolts (in)	Bolt Circle (in)
			90 MPH	110 MPH	120 MPH	150 MPH		
4"	10'	L - 1/8"	20.81	12.81	10.22	5.31	Ø¾" x 26"	Ø8½"
4"	11'	L - 1/8"	18.06	10.82	8.48	4.04	Ø¾" x 26"	Ø8½"
4"	12'	L - 1/8"	15.71	9.10	6.96	2.91	Ø¾" x 26"	Ø8½"
4"	13'	L - 1/8"	13.67	7.58	5.62		Ø¾" x 26"	Ø8½"
4"	14'	L - 1/8"	11.86	6.23	4.40		Ø¾" x 26"	Ø8½"
4"	15'	L - 1/8"	10.24	4.99	3.30		Ø¾" x 26"	Ø8½"
4"	16'	L - 1/8"	8.77	3.86	2.28		Ø¾" x 26"	Ø8½"
4"	17'	L - 1/8"	7.42	2.81			Ø¾" x 26"	Ø8½"
4"	18'	L - 1/8"	6.18				Ø¾" x 26"	Ø8½"
4"	19'	L - 1/8"	5.02				Ø1" x 36"	Ø10"
4"	20'	L - 1/8"	3.94				Ø1" x 36"	Ø10"
4"	21'	L - 1/8"	2.92				Ø1" x 36"	Ø10"

4"	10'	M - 3/16"	31.02	19.64	15.96	8.99	Ø¾" x 26"	Ø8½"
4"	11'	M - 3/16"	27.30	17.00	13.67	7.37	Ø¾" x 26"	Ø8½"
4"	12'	M - 3/16"	24.15	14.75	11.71	5.95	Ø¾" x 26"	Ø8½"
4"	13'	M - 3/16"	21.43	12.78	9.98	4.68	Ø¾" x 26"	Ø8½"
4"	14'	M - 3/16"	19.05	11.04	8.45	3.54	Ø¾" x 26"	Ø8½"
4"	15'	M - 3/16"	16.93	9.47	7.06	2.49	Ø¾" x 26"	Ø8½"
4"	16'	M - 3/16"	15.03	8.05	5.80		Ø¾" x 26"	Ø8½"
4"	17'	M - 3/16"	13.30	6.75	4.63		Ø¾" x 26"	Ø8½"
4"	18'	M - 3/16"	11.72	5.55	3.55		Ø¾" x 26"	Ø8½"
4"	19'	M - 3/16"	10.27	4.42	2.53		Ø¾" x 26"	Ø8½"
4"	20'	M - 3/16"	8.91	3.37			Ø¾" x 26"	Ø8½"
4"	21'	M - 3/16"	7.65	2.37			Ø1" x 36"	Ø10"
4"	22'	M - 3/16"	6.46				Ø1" x 36"	Ø10"
4"	23'	M - 3/16"	5.34				Ø1" x 36"	Ø10"
4"	24'	M - 3/16"	4.27				Ø1" x 36"	Ø10"

4"	10'	W - 5/16"	40.00	31.12	25.61	15.16	Ø¾" x 26"	Ø8½"
4"	11'	W - 5/16"	40.00	27.39	22.40	12.95	Ø¾" x 26"	Ø8½"
4"	12'	W - 5/16"	38.32	24.23	19.67	11.05	Ø¾" x 26"	Ø8½"
4"	13'	W - 5/16"	34.46	21.50	17.31	9.37	Ø¾" x 26"	Ø8½"
4"	14'	W - 5/16"	31.11	19.12	15.23	7.88	Ø¾" x 26"	Ø8½"
4"	15'	W - 5/16"	28.17	16.99	13.38	6.54	Ø¾" x 26"	Ø8½"
4"	16'	W - 5/16"	25.54	15.09	11.71	5.31	Ø¾" x 26"	Ø8½"
4"	17'	W - 5/16"	23.18	13.36	10.18	4.17	Ø¾" x 26"	Ø8½"
4"	18'	W - 5/16"	21.03	11.78	8.78	3.11	Ø¾" x 26"	Ø8½"
4"	19'	W - 5/16"	19.07	10.32	7.49	2.12	Ø¾" x 26"	Ø8½"
4"	20'	W - 5/16"	17.27	8.96	6.28		Ø¾" x 26"	Ø8½"
4"	21'	W - 5/16"	15.60	7.69	5.14		Ø1" x 36"	Ø10"
4"	22'	W - 5/16"	14.04	6.50	4.07		Ø1" x 36"	Ø10"
4"	23'	W - 5/16"	12.58	5.38	3.05		Ø1" x 36"	Ø10"
4"	24'	W - 5/16"	11.20	4.31	2.08		Ø1" x 36"	Ø10"

Consult factory for reinforcement solutions for higher EPA ratings.

STRAIGHT POLE
EPA RATING TABLE - AASHTO

Steel
Square Shape

Dimension (in)	Height (ft)	Wall Thickness (in)	EPA Rating (sq.ft.)				Anchor Bolts (in)	Bolt Circle (in)
			90MPH	110MPH	120MPH	150MPH		
5"	10'	L - 1/8"	28.40	17.60	14.11	7.50	Ø¾" x 26"	Ø10"
5"	11'	L - 1/8"	24.73	14.97	11.81	5.83	Ø¾" x 26"	Ø10"
5"	12'	L - 1/8"	21.61	12.69	9.81	4.34	Ø¾" x 26"	Ø10"
5"	13'	L - 1/8"	18.90	10.69	8.04	3.01	Ø¾" x 26"	Ø10"
5"	14'	L - 1/8"	16.50	8.90	6.45		Ø¾" x 26"	Ø10"
5"	15'	L - 1/8"	14.36	7.29	5.00		Ø¾" x 26"	Ø10"
5"	16'	L - 1/8"	12.42	5.81	3.67		Ø¾" x 26"	Ø10"
5"	17'	L - 1/8"	10.65	4.44	2.43		Ø¾" x 26"	Ø10"
5"	18'	L - 1/8"	9.02	3.16			Ø¾" x 26"	Ø10"
5"	19'	L - 1/8"	7.50				Ø¾" x 26"	Ø10"
5"	20'	L - 1/8"	6.08				Ø¾" x 26"	Ø10"
5"	21'	L - 1/8"	4.75				Ø1" x 36"	Ø11.5"
5"	22'	L - 1/8"	3.49				Ø1" x 36"	Ø11.5"
5"	23'	L - 1/8"	2.29				Ø1" x 36"	Ø11.5"

5"	10'	M - 3/16"	40.00	33.71	27.64	16.16	Ø¾" x 26"	Ø10"
5"	11'	M - 3/16"	40.00	29.54	24.05	13.66	Ø¾" x 26"	Ø10"
5"	12'	M - 3/16"	40.00	26.00	20.99	11.50	Ø¾" x 26"	Ø10"
5"	13'	M - 3/16"	37.18	22.93	18.32	9.59	Ø¾" x 26"	Ø10"
5"	14'	M - 3/16"	33.43	20.24	15.97	7.89	Ø¾" x 26"	Ø10"
5"	15'	M - 3/16"	30.12	17.84	13.86	6.34	Ø¾" x 26"	Ø10"
5"	16'	M - 3/16"	27.17	15.68	11.96	4.92	Ø¾" x 26"	Ø10"
5"	17'	M - 3/16"	24.50	13.71	10.22	3.60	Ø¾" x 26"	Ø10"
5"	18'	M - 3/16"	22.08	11.90	8.61	2.37	Ø¾" x 26"	Ø10"
5"	19'	M - 3/16"	19.86	10.23	7.11		Ø¾" x 26"	Ø10"
5"	20'	M - 3/16"	17.80	8.67	5.72		Ø¾" x 26"	Ø10"
5"	21'	M - 3/16"	15.90	7.21	4.40		Ø1" x 36"	Ø11.5"
5"	22'	M - 3/16"	14.12	5.83	3.15		Ø1" x 36"	Ø11.5"
5"	23'	M - 3/16"	12.44	4.53			Ø1" x 36"	Ø11.5"
5"	24'	M - 3/16"	10.87	3.29			Ø1" x 36"	Ø11.5"
5"	25'	M - 3/16"	9.37	2.10			Ø1" x 36"	Ø11.5"
5"	26'	M - 3/16"	7.95				Ø1" x 36"	Ø11.5"
5"	27'	M - 3/16"	6.59				Ø1" x 36"	Ø11.5"
5"	28'	M - 3/16"	5.30				Ø1" x 36"	Ø11.5"
5"	29'	M - 3/16"	4.05				Ø1" x 36"	Ø11.5"
5"	30'	M - 3/16"	2.85				Ø1" x 36"	Ø11.5"

Consult factory for reinforcement solutions for higher EPA ratings.

STRAIGHT POLE
EPA RATING TABLE - AASHTO

Steel
Square Shape

Dimension (in)	Height (ft)	Wall Thickness (in)	EPA Rating (sq.ft.)				Anchor Bolts (in)	Bolt Circle (in)
			90MPH	110MPH	120MPH	150MPH		
5"	10'	H - ¼"	40.00	40.00	35.66	21.29	Ø¾" x 26"	Ø10"
5"	11'	H - ¼"	40.00	38.16	31.30	18.30	Ø¾" x 26"	Ø10"
5"	12'	H - ¼"	40.00	33.87	27.60	15.74	Ø¾" x 26"	Ø10"
5"	13'	H - ¼"	40.00	30.18	24.41	13.49	Ø¾" x 26"	Ø10"
5"	14'	H - ¼"	40.00	26.95	21.61	11.50	Ø¾" x 26"	Ø10"
5"	15'	H - ¼"	39.45	24.08	19.11	9.70	Ø¾" x 26"	Ø10"
5"	16'	H - ¼"	35.90	21.52	16.87	8.06	Ø¾" x 26"	Ø10"
5"	17'	H - ¼"	32.70	19.20	14.83	6.56	Ø¾" x 26"	Ø10"
5"	18'	H - ¼"	29.81	17.08	12.96	5.16	Ø¾" x 26"	Ø10"
5"	19'	H - ¼"	27.17	15.12	11.23	3.85	Ø¾" x 26"	Ø10"
5"	20'	H - ¼"	24.74	13.32	9.62	2.62	Ø¾" x 26"	Ø10"
5"	21'	H - ¼"	22.50	11.63	8.11		Ø1" x 36"	Ø11.5"
5"	22'	H - ¼"	20.41	10.05	6.69		Ø1" x 36"	Ø11.5"
5"	23'	H - ¼"	18.46	8.55	5.35		Ø1" x 36"	Ø11.5"
5"	24'	H - ¼"	16.63	7.14	4.08		Ø1" x 36"	Ø11.5"
5"	25'	H - ¼"	14.90	5.80	2.86		Ø1" x 36"	Ø11.5"
5"	26'	H - ¼"	13.26	4.52			Ø1" x 36"	Ø11.5"
5"	27'	H - ¼"	11.70	3.29			Ø1" x 36"	Ø11.5"
5"	28'	H - ¼"	10.22	2.11			Ø1" x 36"	Ø11.5"
5"	29'	H - ¼"	8.80				Ø1" x 36"	Ø11.5"
5"	30'	H - ¼"	7.44				Ø1" x 36"	Ø11.5"

5"	10'	W - 5/16"	40.00	40.00	40.00	31.67	Ø¾" x 26"	Ø10"
5"	11'	W - 5/16"	40.00	40.00	40.00	27.70	Ø¾" x 26"	Ø10"
5"	12'	W - 5/16"	40.00	40.00	40.00	24.32	Ø¾" x 26"	Ø10"
5"	13'	W - 5/16"	40.00	40.00	36.75	21.39	Ø¾" x 26"	Ø10"
5"	14'	W - 5/16"	40.00	40.54	33.03	18.81	Ø¾" x 26"	Ø10"
5"	15'	W - 5/16"	40.00	36.74	29.75	16.51	Ø¾" x 26"	Ø10"
5"	16'	W - 5/16"	40.00	33.36	26.82	14.43	Ø¾" x 26"	Ø10"
5"	17'	W - 5/16"	40.00	30.32	24.17	12.54	Ø¾" x 26"	Ø10"
5"	18'	W - 5/16"	40.00	27.56	21.77	10.80	Ø¾" x 26"	Ø10"
5"	19'	W - 5/16"	40.00	25.04	19.56	9.18	Ø¾" x 26"	Ø10"
5"	20'	W - 5/16"	38.80	22.73	17.53	7.68	Ø¾" x 26"	Ø10"
5"	21'	W - 5/16"	35.87	20.58	15.63	6.27	Ø1" x 36"	Ø11.5"
5"	22'	W - 5/16"	33.16	18.58	13.87	4.93	Ø1" x 36"	Ø11.5"
5"	23'	W - 5/16"	30.64	16.71	12.20	3.67	Ø1" x 36"	Ø11.5"
5"	24'	W - 5/16"	28.29	14.95	10.64	2.47	Ø1" x 36"	Ø11.5"
5"	25'	W - 5/16"	26.08	13.29	9.15		Ø1" x 36"	Ø11.5"
5"	26'	W - 5/16"	24.01	11.71	7.74		Ø1" x 36"	Ø11.5"
5"	27'	W - 5/16"	22.04	10.22	6.39		Ø1" x 36"	Ø11.5"
5"	28'	W - 5/16"	20.18	8.79	5.10		Ø1" x 36"	Ø11.5"
5"	29'	W - 5/16"	18.42	7.42	3.86		Ø1" x 36"	Ø11.5"
5"	30'	W - 5/16"	16.73	6.10	2.67		Ø1" x 36"	Ø11.5"

Consult factory for reinforcement solutions for higher EPA ratings.

STRAIGHT POLE EPA RATING TABLE - AASHTO

STRAIGHT POLE EPA RATING TABLE - AASHTO

STRAIGHT POLE
EPA RATING TABLE - AASHTO

Steel
Square Shape

Dimension (in)	Height (ft)	Wall Thickness (in)	EPA Rating (sq.ft.)				Anchor Bolts (in)	Bolt Circle (in)
			90 MPH	110 MPH	120 MPH	150 MPH		
6"	10'	M - 3/16"	40.00	40.00	40.00	27.76	Ø¾" x 26"	Ø11.5"
6"	11'	M - 3/16"	40.00	40.00	40.69	23.96	Ø¾" x 26"	Ø11.5"
6"	12'	M - 3/16"	40.00	40.00	35.98	20.71	Ø¾" x 26"	Ø11.5"
6"	13'	M - 3/16"	40.00	39.34	31.92	17.87	Ø¾" x 26"	Ø11.5"
6"	14'	M - 3/16"	40.00	35.23	28.36	15.35	Ø¾" x 26"	Ø11.5"
6"	15'	M - 3/16"	40.00	31.60	25.20	13.09	Ø¾" x 26"	Ø11.5"
6"	16'	M - 3/16"	40.00	28.34	22.36	11.03	Ø¾" x 26"	Ø11.5"
6"	17'	M - 3/16"	40.00	25.41	19.79	9.14	Ø¾" x 26"	Ø11.5"
6"	18'	M - 3/16"	39.11	22.72	17.43	7.39	Ø¾" x 26"	Ø11.5"
6"	19'	M - 3/16"	35.76	20.26	15.25	5.76	Ø¾" x 26"	Ø11.5"
6"	20'	M - 3/16"	32.69	17.98	13.23	4.22	Ø¾" x 26"	Ø11.5"
6"	21'	M - 3/16"	29.85	15.86	11.34	2.77	Ø1" x 36"	Ø14"
6"	22'	M - 3/16"	27.21	13.87	9.56		Ø1" x 36"	Ø14"
6"	23'	M - 3/16"	24.74	12.00	7.88		Ø1" x 36"	Ø14"
6"	24'	M - 3/16"	22.43	10.23	6.29		Ø1" x 36"	Ø14"
6"	25'	M - 3/16"	20.26	8.55	4.77		Ø1" x 36"	Ø14"
6"	26'	M - 3/16"	18.20	6.96	3.32		Ø1" x 36"	Ø14"
6"	27'	M - 3/16"	16.24	5.43			Ø1" x 36"	Ø14"
6"	28'	M - 3/16"	14.38	3.96			Ø1" x 36"	Ø14"
6"	29'	M - 3/16"	12.61	2.55			Ø1" x 36"	Ø14"
6"	30'	M - 3/16"	10.90				Ø1" x 36"	Ø14"

6"	10'	H - ¼"	40.00	40.00	40.00	37.15	Ø¾" x 26"	Ø11.5"
6"	11'	H - ¼"	40.00	40.00	40.00	32.46	Ø¾" x 26"	Ø11.5"
6"	12'	H - ¼"	40.00	40.00	40.00	28.47	Ø¾" x 26"	Ø11.5"
6"	13'	H - ¼"	40.00	40.00	40.00	25.01	Ø¾" x 26"	Ø11.5"
6"	14'	H - ¼"	40.00	40.00	38.69	21.96	Ø¾" x 26"	Ø11.5"
6"	15'	H - ¼"	40.00	40.00	34.82	19.24	Ø¾" x 26"	Ø11.5"
6"	16'	H - ¼"	40.00	39.05	31.36	16.79	Ø¾" x 26"	Ø11.5"
6"	17'	H - ¼"	40.00	35.46	28.24	14.55	Ø¾" x 26"	Ø11.5"
6"	18'	H - ¼"	40.00	32.21	25.39	12.49	Ø¾" x 26"	Ø11.5"
6"	19'	H - ¼"	40.00	29.23	22.79	10.58	Ø¾" x 26"	Ø11.5"
6"	20'	H - ¼"	40.00	26.49	20.38	8.80	Ø¾" x 26"	Ø11.5"
6"	21'	H - ¼"	40.00	23.96	18.14	7.12	Ø1" x 36"	Ø14"
6"	22'	H - ¼"	38.74	21.59	16.05	5.54	Ø1" x 36"	Ø14"
6"	23'	H - ¼"	35.76	19.38	14.08	4.04	Ø1" x 36"	Ø14"
6"	24'	H - ¼"	32.98	17.30	12.22	2.61	Ø1" x 36"	Ø14"
6"	25'	H - ¼"	30.38	15.33	10.46		Ø1" x 36"	Ø14"
6"	26'	H - ¼"	27.92	13.46	8.79		Ø1" x 36"	Ø14"
6"	27'	H - ¼"	25.60	11.69	7.19		Ø1" x 36"	Ø14"
6"	28'	H - ¼"	23.40	9.99	5.66		Ø1" x 36"	Ø14"
6"	29'	H - ¼"	21.30	8.37	4.19		Ø1" x 36"	Ø14"
6"	30'	H - ¼"	19.31	6.81	2.77		Ø1" x 36"	Ø14"

Consult factory for reinforcement solutions for higher EPA ratings.

STRAIGHT POLE
EPA RATING TABLE - AASHTO

Aluminum
Fluted Shape

Dimension (in)	Height (ft)	Wall Thickness (in)	EPA Rating (sq.ft.)				Anchor Bolts (in)	Bolt Circle (in)
			90 MPH	110 MPH	120 MPH	150 MPH		
4"	10'	M - 3/16"	8.00	4.81	3.77		Ø¾" x 26"	Ø8½"
4"	11'	M - 3/16"	7.01	4.08	3.14		Ø¾" x 26"	Ø8½"
4"	12'	M - 3/16"	6.15	3.45	2.57		Ø¾" x 26"	Ø8½"
4"	13'	M - 3/16"	5.38	2.87	2.06		Ø¾" x 26"	Ø8½"
4"	14'	M - 3/16"	4.69	2.35			Ø¾" x 26"	Ø8½"
4"	15'	M - 3/16"	4.07				Ø¾" x 26"	Ø8½"
4"	16'	M - 3/16"	3.50				Ø¾" x 26"	Ø8½"
4"	17'	M - 3/16"	2.96				Ø¾" x 26"	Ø8½"
4"	18'	M - 3/16"	2.47				Ø¾" x 26"	Ø8½"
4"	19'	M - 3/16"	2.01				Ø¾" x 26"	Ø8½"

5"	10'	M - 3/16"	17.05	10.73	8.74	5.38	Ø¾" x 26"	Ø10"
5"	11'	M - 3/16"	15.23	9.43	7.63	4.64	Ø¾" x 26"	Ø10"
5"	12'	M - 3/16"	13.65	8.30	6.65	3.99	Ø¾" x 26"	Ø10"
5"	13'	M - 3/16"	12.27	7.30	5.77	3.41	Ø¾" x 26"	Ø10"
5"	14'	M - 3/16"	11.04	6.40	4.99	2.88	Ø¾" x 26"	Ø10"
5"	15'	M - 3/16"	9.93	5.58	4.28	2.40	Ø¾" x 26"	Ø10"
5"	16'	M - 3/16"	8.93	4.84	3.62		Ø¾" x 26"	Ø10"
5"	17'	M - 3/16"	8.01	4.15	3.01		Ø¾" x 26"	Ø10"
5"	18'	M - 3/16"	7.17	3.51	2.44		Ø¾" x 26"	Ø10"
5"	19'	M - 3/16"	6.39	2.91			Ø¾" x 26"	Ø10"
5"	20'	M - 3/16"	5.66	2.34			Ø¾" x 26"	Ø10"

Consult factory for internal reinforcement solutions for higher EPA ratings.



MUFFLER POLE

TECHNICAL INFORMATION

Muffler Pole

Technical Information

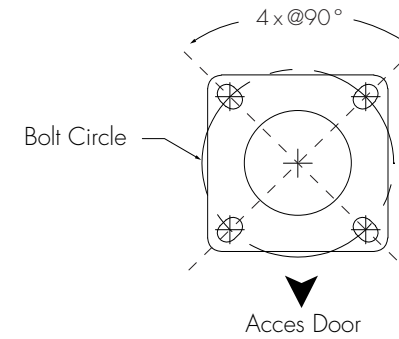
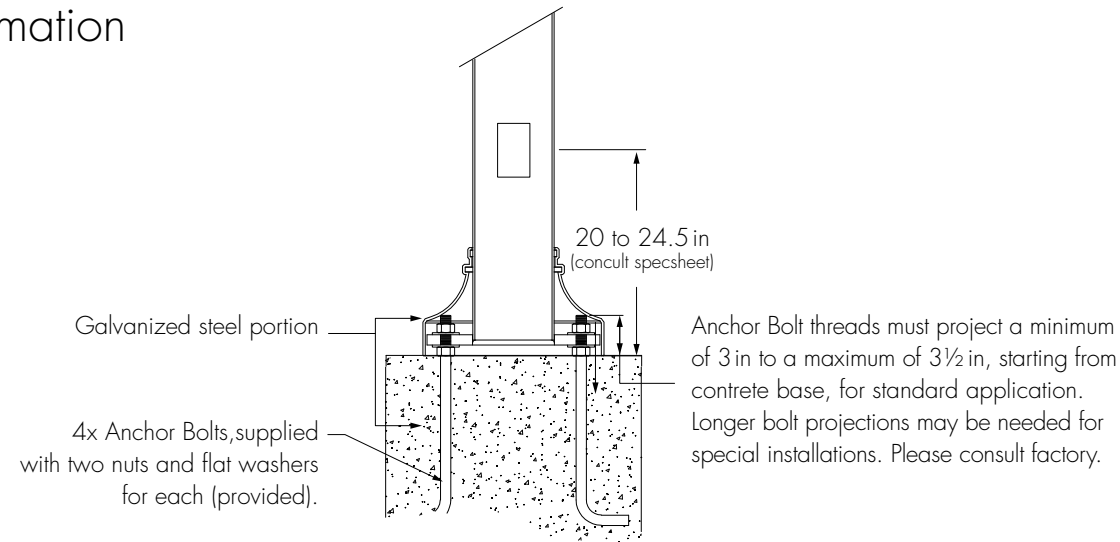

		Round Shapes			
		4 in	4 in	4 in	5 in
		Q5F [5 in]	Q6 [6 in]	Q8 [8 in]	Q8 [8 in]
Wall Thickness*	Aluminium	L - M - H - W	L - M - H - W	L - M - H - W	L - M - H - W
	Steel	L - M - H - W	L - M - H - W	L - M - H - W	L - M - H - W
Maximum Height	Aluminium	Up to 20ft	Up to 22ft		
	Steel	N/A	Up to 22ft		Up to 30ft
Compatible Base Cover Options		QF	QB6, QC6, QJ6	QB8, QC8, QM8, QT8	
Compatible Accessories		LR41, LR42 LH41, LH42			LR51, LR52
Anchor Bolts	Up to 22ft	Ø3/4 in x 26 in			Ø3/4 in x 26 in Ø1 in x 36 in (steel only)
	23ft to 30ft	N/A			Ø1 in x 36 in (steel only)
Bolt Circle	Up to 22ft	Ø10 in		Ø11.5 in	
	23ft to 30ft	N/A			Ø11.5 in

Fluted Shapes			
4 in	4 in	4 in	5 in
Q5F [5 in]	Q6 [6 in]	Q8 [8 in]	Q8 [8 in]
M	M	M	M
N/A	N/A	N/A	N/A
Up to 20ft	Up to 22ft		
N/A			
QF	QB6, QC6, QJ6	QB8, QC8, QM8, QT8	
LR41, LR42 LH41, LH42			LR51, LR52
Ø3/4 in x 26 in			
N/A			
Ø10 in		Ø11.5 in	
N/A			

*For maximum wall thickness and height limitations, please consult the Muffler Pole EPA Rating Table.

Muffler Pole

Technical Information

Base Cover Options

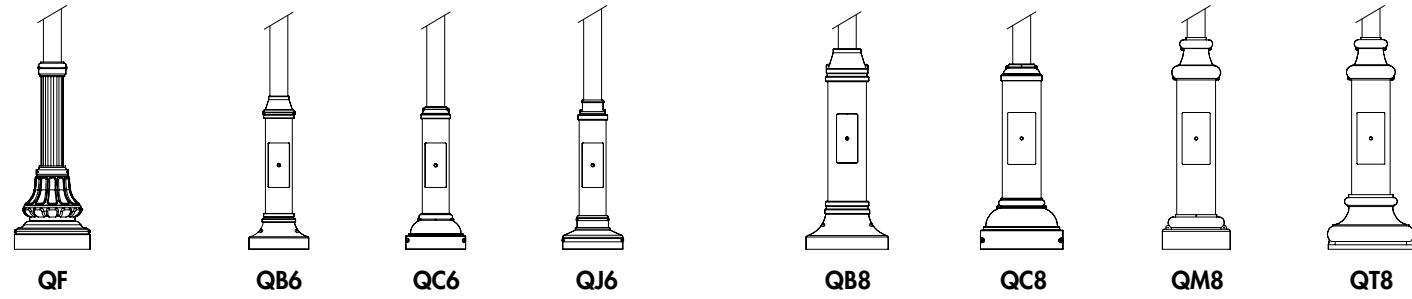

Banner Arm Accessories

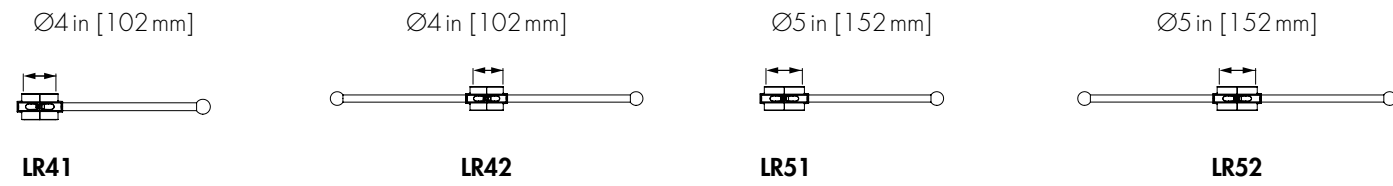

Basket Holder Accessories

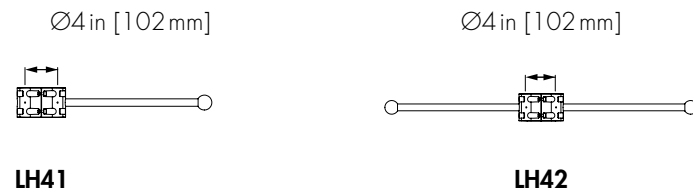

Pole-Top Options

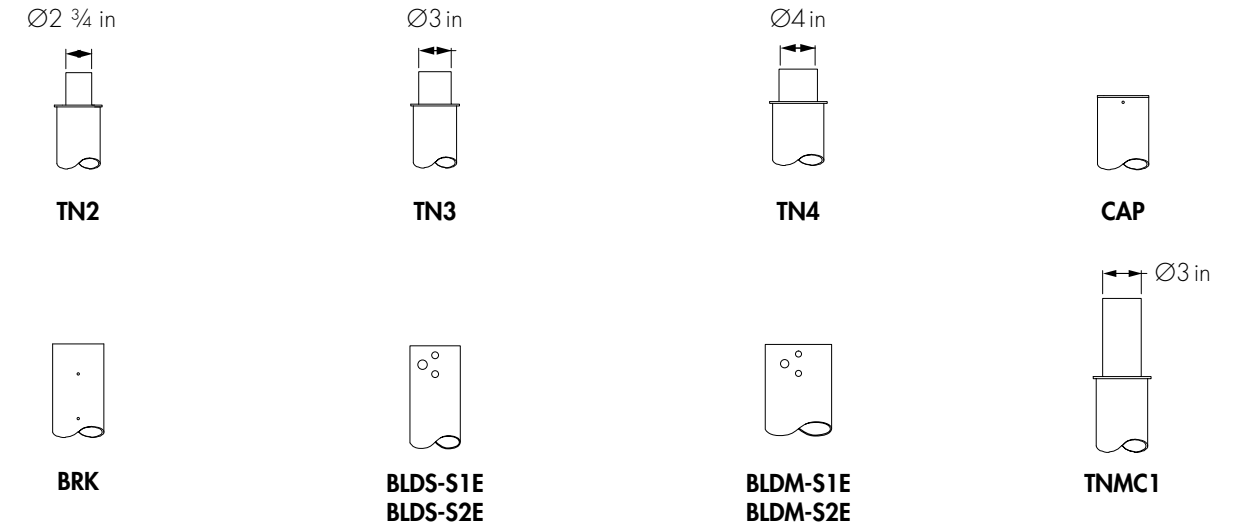

Other Options

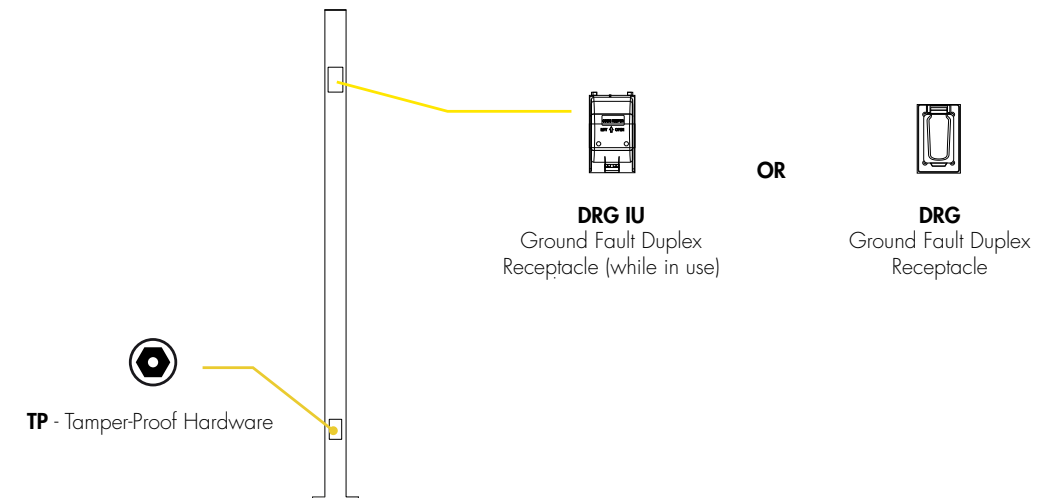

Finish Options

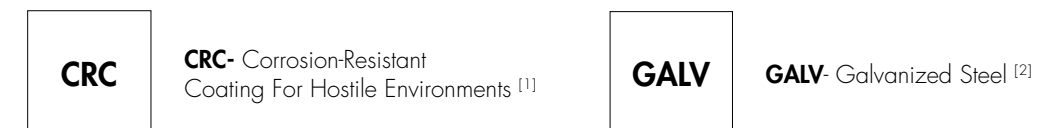

[1] Automatically included when a steel pole is specified.

[2] Only available for steel poles with textured finish [immersion marks may occur].

MUFFLER POLE

EPA RATING TABLE - AASHTO

MUFFLER POLE
EPA RATING TABLE - AASHTO

Aluminium
Round Shape - Q5F Muffler Base

Pole Dimension (in)	Height (ft)	Wall Thickness (in)	EPA Rating (sq.ft.)				Anchor Bolts (in)	Bolt Circle (in)
			90MPH	110MPH	120MPH	150MPH		
4"	10'	L - 1/8"	9.32	5.89	4.81	2.97	Ø¾" x 26"	Ø10"
4"	11'	L - 1/8"	7.94	4.91	3.96	2.41	Ø¾" x 26"	Ø10"
4"	12'	L - 1/8"	6.81	4.09	3.25		Ø¾" x 26"	Ø10"
4"	13'	L - 1/8"	5.86	3.39	2.64		Ø¾" x 26"	Ø10"
4"	14'	L - 1/8"	5.04	2.78	2.11		Ø¾" x 26"	Ø10"
4"	15'	L - 1/8"	4.32	2.24			Ø¾" x 26"	Ø10"
4"	16'	L - 1/8"	3.67				Ø¾" x 26"	Ø10"
4"	17'	L - 1/8"	3.09				Ø¾" x 26"	Ø10"
4"	18'	L - 1/8"	2.57				Ø¾" x 26"	Ø10"
4"	19'	L - 1/8"	2.08				Ø¾" x 26"	Ø10"

4"	10'	M - 3/16"	13.79	8.88	7.32	4.58	Ø¾" x 26"	Ø10"
4"	11'	M - 3/16"	11.90	7.55	6.19	3.83	Ø¾" x 26"	Ø10"
4"	12'	M - 3/16"	10.35	6.46	5.24	3.21	Ø¾" x 26"	Ø10"
4"	13'	M - 3/16"	9.07	5.54	4.45	2.68	Ø¾" x 26"	Ø10"
4"	14'	M - 3/16"	7.97	4.75	3.76	2.22	Ø¾" x 26"	Ø10"
4"	15'	M - 3/16"	7.02	4.05	3.15		Ø¾" x 26"	Ø10"
4"	16'	M - 3/16"	6.18	3.43	2.60		Ø¾" x 26"	Ø10"
4"	17'	M - 3/16"	5.43	2.86	2.10		Ø¾" x 26"	Ø10"
4"	18'	M - 3/16"	4.75	2.35			Ø¾" x 26"	Ø10"
4"	19'	M - 3/16"	4.13				Ø¾" x 26"	Ø10"
4"	20'	M - 3/16"	3.56				Ø¾" x 26"	Ø10"
4"	21'	M - 3/16"	3.03				Ø¾" x 26"	Ø10"
4"	22'	M - 3/16"	2.54				Ø¾" x 26"	Ø10"

4"	10'	H - ¼"	17.33	11.00	9.01	5.58	Ø¾" x 26"	Ø10"
4"	11'	H - ¼"	15.46	9.75	7.94	4.87	Ø¾" x 26"	Ø10"
4"	12'	H - ¼"	13.55	8.60	7.00	4.25	Ø¾" x 26"	Ø10"
4"	13'	H - ¼"	11.97	7.48	6.08	3.70	Ø¾" x 26"	Ø10"
4"	14'	H - ¼"	10.62	6.52	5.25	3.17	Ø¾" x 26"	Ø10"
4"	15'	H - ¼"	9.46	5.68	4.52	2.69	Ø¾" x 26"	Ø10"
4"	16'	H - ¼"	8.44	4.94	3.87	2.25	Ø¾" x 26"	Ø10"
4"	17'	H - ¼"	7.54	4.27	3.29		Ø¾" x 26"	Ø10"
4"	18'	H - ¼"	6.72	3.67	2.76		Ø¾" x 26"	Ø10"
4"	19'	H - ¼"	5.99	3.11	2.27		Ø¾" x 26"	Ø10"
4"	20'	H - ¼"	5.31	2.60			Ø¾" x 26"	Ø10"
4"	21'	H - ¼"	4.69	2.13			Ø¾" x 26"	Ø10"
4"	22'	H - ¼"	4.11				Ø¾" x 26"	Ø10"

Consult factory for reinforcement solutions for higher EPA ratings.

MUFFLER POLE
EPA RATING TABLE - AASHTO

Aluminium
Round Shape - Q5F Muffler Base

Pole Dimension (in)	Height (ft)	Wall Thickness (in)	EPA Rating (sq.ft.)				Anchor Bolts (in)	Bolt Circle (in)
			90MPH	110MPH	120MPH	150MPH		
4"	10'	W - 5/16"	17.33	11.00	9.01	5.58	Ø¾" x 26"	Ø10"
4"	11'	W - 5/16"	15.55	9.75	7.94	4.87	Ø¾" x 26"	Ø10"
4"	12'	W - 5/16"	14.02	8.67	7.00	4.25	Ø¾" x 26"	Ø10"
4"	13'	W - 5/16"	12.68	7.71	6.17	3.70	Ø¾" x 26"	Ø10"
4"	14'	W - 5/16"	11.49	6.85	5.43	3.21	Ø¾" x 26"	Ø10"
4"	15'	W - 5/16"	10.43	6.08	4.76	2.76	Ø¾" x 26"	Ø10"
4"	16'	W - 5/16"	9.48	5.38	4.15	2.35	Ø¾" x 26"	Ø10"
4"	17'	W - 5/16"	8.61	4.74	3.58		Ø¾" x 26"	Ø10"
4"	18'	W - 5/16"	7.81	4.14	3.06		Ø¾" x 26"	Ø10"
4"	19'	W - 5/16"	7.07	3.59	2.57		Ø¾" x 26"	Ø10"
4"	20'	W - 5/16"	6.39	3.07	2.11		Ø¾" x 26"	Ø10"
4"	21'	W - 5/16"	5.75	2.58			Ø¾" x 26"	Ø10"
4"	22'	W - 5/16"	5.15	2.12			Ø¾" x 26"	Ø10"

Consult factory for reinforcement solutions for higher EPA ratings.

MUFFLER POLE
EPA RATING TABLE - AASHTO

Aluminium
Fluted Shape - Q5F Muffler Base

Pole Dimension (in)	Height (ft)	Wall Thickness (in)	EPA Rating (sq.ft.)				Anchor Bolts (in)	Bolt Circle (in)
			90MPH	110MPH	120MPH	150MPH		
4"	10'	M - 3/16"	12.81	8.22	6.74	3.96	Ø¾" x 26"	Ø10"
4"	11'	M - 3/16"	11.03	6.97	5.66	3.21	Ø¾" x 26"	Ø10"
4"	12'	M - 3/16"	9.58	5.94	4.76	2.58	Ø¾" x 26"	Ø10"
4"	13'	M - 3/16"	8.36	5.07	4.00	2.03	Ø¾" x 26"	Ø10"
4"	14'	M - 3/16"	7.33	4.31	3.34		Ø¾" x 26"	Ø10"
4"	15'	M - 3/16"	6.43	3.65	2.75		Ø¾" x 26"	Ø10"
4"	16'	M - 3/16"	5.63	3.06	2.22		Ø¾" x 26"	Ø10"
4"	17'	M - 3/16"	4.92	2.52			Ø¾" x 26"	Ø10"
4"	18'	M - 3/16"	4.27	2.03			Ø¾" x 26"	Ø10"
4"	19'	M - 3/16"	3.68				Ø¾" x 26"	Ø10"
4"	20'	M - 3/16"	3.14				Ø¾" x 26"	Ø10"
4"	21'	M - 3/16"	2.63				Ø¾" x 26"	Ø10"
4"	21'	M - 3/16"	2.16				Ø¾" x 26"	Ø10"

Consult factory for reinforcement solutions for higher EPA ratings.

MUFFLER POLE
EPA RATING TABLE - AASHTO

Aluminium
Fluted Shape - Q6 Muffler Base

Pole Dimension (in)	Height (ft)	Wall Thickness (in)	EPA Rating (sq.ft.)				Anchor Bolts (in)	Bolt Circle (in)
			90MPH	110MPH	120MPH	150MPH		
4"	10'	L - 1/8"	9.32	6.04	5.03	3.13	Ø¾" x 26"	Ø10"
4"	11'	L - 1/8"	7.94	5.09	4.22	2.60	Ø¾" x 26"	Ø10"
4"	12'	L - 1/8"	6.81	4.29	3.54	2.15	Ø¾" x 26"	Ø10"
4"	13'	L - 1/8"	5.86	3.62	2.97		Ø¾" x 26"	Ø10"
4"	14'	L - 1/8"	5.04	3.04	2.47		Ø¾" x 26"	Ø10"
4"	15'	L - 1/8"	4.32	2.52	2.03		Ø¾" x 26"	Ø10"
4"	16'	L - 1/8"	3.67	2.06			Ø¾" x 26"	Ø10"
4"	17'	L - 1/8"	3.09				Ø¾" x 26"	Ø10"
4"	18'	L - 1/8"	2.57				Ø¾" x 26"	Ø10"
4"	19'	L - 1/8"	2.08				Ø¾" x 26"	Ø10"

4"	10'	M - 3/16"	13.79	9.03	7.54	4.74	Ø¾" x 26"	Ø10"
4"	11'	M - 3/16"	11.90	7.73	6.44	4.02	Ø¾" x 26"	Ø10"
4"	12'	M - 3/16"	10.35	6.67	5.54	3.43	Ø¾" x 26"	Ø10"
4"	13'	M - 3/16"	9.07	5.77	4.78	2.92	Ø¾" x 26"	Ø10"
4"	14'	M - 3/16"	7.97	5.00	4.12	2.49	Ø¾" x 26"	Ø10"
4"	15'	M - 3/16"	7.02	4.33	3.55	2.11	Ø¾" x 26"	Ø10"
4"	16'	M - 3/16"	6.18	3.73	3.04		Ø¾" x 26"	Ø10"
4"	17'	M - 3/16"	5.43	3.20	2.58		Ø¾" x 26"	Ø10"
4"	18'	M - 3/16"	4.75	2.71	2.16		Ø¾" x 26"	Ø10"
4"	19'	M - 3/16"	4.13	2.26			Ø¾" x 26"	Ø10"
4"	20'	M - 3/16"	3.56				Ø¾" x 26"	Ø10"
4"	21'	M - 3/16"	3.03				Ø¾" x 26"	Ø10"
4"	22'	M - 3/16"	2.54				Ø¾" x 26"	Ø10"

4"	10'	H - ¼"	14.86	9.58	7.96	4.94	Ø¾" x 26"	Ø10"
4"	11'	H - ¼"	13.27	8.49	7.04	4.33	Ø¾" x 26"	Ø10"
4"	12'	H - ¼"	11.91	7.54	6.23	3.79	Ø¾" x 26"	Ø10"
4"	13'	H - ¼"	10.71	6.70	5.52	3.32	Ø¾" x 26"	Ø10"
4"	14'	H - ¼"	9.64	5.95	4.88	2.90	Ø¾" x 26"	Ø10"
4"	15'	H - ¼"	8.69	5.28	4.31	2.52	Ø¾" x 26"	Ø10"
4"	16'	H - ¼"	7.82	4.67	3.78	2.17	Ø¾" x 26"	Ø10"
4"	17'	H - ¼"	7.04	4.11	3.30		Ø¾" x 26"	Ø10"
4"	18'	H - ¼"	6.31	3.59	2.86		Ø¾" x 26"	Ø10"
4"	19'	H - ¼"	5.64	3.10	2.45		Ø¾" x 26"	Ø10"
4"	20'	H - ¼"	5.02	2.65	2.06		Ø¾" x 26"	Ø10"
4"	21'	H - ¼"	4.43	2.23			Ø¾" x 26"	Ø10"
4"	22'	H - ¼"	3.89				Ø¾" x 26"	Ø10"

Consult factory for reinforcement solutions for higher EPA ratings.

MUFFLER POLE
EPA RATING TABLE - AASHTO

Aluminium
Round Shape - Q6 Muffler Base

Pole Dimension (in)	Height (ft)	Wall Thickness (in)	EPA Rating (sq.ft.)				Anchor Bolts (in)	Bolt Circle (in)
			90MPH	110MPH	120MPH	150MPH		
4"	10'	L - 1/8"	9.32	6.04	5.03	3.13	Ø¾" x 26"	Ø10"
4"	11'	L - 1/8"	7.94	5.09	4.22	2.60	Ø¾" x 26"	Ø10"
4"	12'	L - 1/8"	6.81	4.29	3.54	2.15	Ø¾" x 26"	Ø10"
4"	13'	L - 1/8"	5.86	3.62	2.97		Ø¾" x 26"	Ø10"
4"	14'	L - 1/8"	5.04	3.04	2.47		Ø¾" x 26"	Ø10"
4"	15'	L - 1/8"	4.32	2.52	2.03		Ø¾" x 26"	Ø10"
4"	16'	L - 1/8"	3.67	2.06			Ø¾" x 26"	Ø10"
4"	17'	L - 1/8"	3.09				Ø¾" x 26"	Ø10"
4"	18'	L - 1/8"	2.57				Ø¾" x 26"	Ø10"
4"	19'	L - 1/8"	2.08				Ø¾" x 26"	Ø10"

4"	10'	M - 3/16"	13.79	9.03	7.54	4.74	Ø¾" x 26"	Ø10"
4"	11'	M - 3/16"	11.90	7.73	6.44	4.02	Ø¾" x 26"	Ø10"
4"	12'	M - 3/16"	10.35	6.67	5.54	3.43	Ø¾" x 26"	Ø10"
4"	13'	M - 3/16"	9.07	5.77	4.78	2.92	Ø¾" x 26"	Ø10"
4"	14'	M - 3/16"	7.97	5.00	4.12	2.49	Ø¾" x 26"	Ø10"
4"	15'	M - 3/16"	7.02	4.33	3.55	2.11	Ø¾" x 26"	Ø10"
4"	16'	M - 3/16"	6.18	3.73	3.04		Ø¾" x 26"	Ø10"
4"	17'	M - 3/16"	5.43	3.20	2.58		Ø¾" x 26"	Ø10"
4"	18'	M - 3/16"	4.75	2.71	2.16		Ø¾" x 26"	Ø10"
4"	19'	M - 3/16"	4.13	2.26			Ø¾" x 26"	Ø10"
4"	20'	M - 3/16"	3.56				Ø¾" x 26"	Ø10"
4"	21'	M - 3/16"	3.03				Ø¾" x 26"	Ø10"
4"	22'	M - 3/16"	2.54				Ø¾" x 26"	Ø10"

4"	10'	H - ¼"	14.86	9.58	7.96	4.94	Ø¾" x 26"	Ø10"
4"	11'	H - ¼"	13.27	8.49	7.04	4.33	Ø¾" x 26"	Ø10"
4"	12'	H - ¼"	11.91	7.54	6.23	3.79	Ø¾" x 26"	Ø10"
4"	13'	H - ¼"	10.71	6.70	5.52	3.32	Ø¾" x 26"	Ø10"
4"	14'	H - ¼"	9.64	5.95	4.88	2.90	Ø¾" x 26"	Ø10"
4"	15'	H - ¼"	8.69	5.28	4.31	2.52	Ø¾" x 26"	Ø10"
4"	16'	H - ¼"	7.82	4.67	3.78	2.17	Ø¾" x 26"	Ø10"
4"	17'	H - ¼"	7.04	4.11	3.30		Ø¾" x 26"	Ø10"
4"	18'	H - ¼"	6.31	3.59	2.86		Ø¾" x 26"	Ø10"
4"	19'	H - ¼"	5.64	3.10	2.45		Ø¾" x 26"	Ø10"
4"	20'	H - ¼"	5.02	2.65	2.06		Ø¾" x 26"	Ø10"
4"	21'	H - ¼"	4.43	2.23			Ø¾" x 26"	Ø10"
4"	22'	H - ¼"	3.89				Ø¾" x 26"	Ø10"

Consult factory for reinforcement solutions for higher EPA ratings.

MUFFLER POLE
EPA RATING TABLE - AASHTO

Aluminium
Round Shape - Q6 Muffler Base

Pole Dimension (in)	Height (ft)	Wall Thickness (in)	EPA Rating (sq.ft.)				Anchor Bolts (in)	Bolt Circle (in)
			90MPH	110MPH	120MPH	150MPH		
4"	10'	W - 5/16"	14.86	9.58	7.96	4.94	Ø¾" x 26"	Ø10"
4"	11'	W - 5/16"	13.27	8.49	7.04	4.33	Ø¾" x 26"	Ø10"
4"	12'	W - 5/16"	11.91	7.54	6.23	3.79	Ø¾" x 26"	Ø10"
4"	13'	W - 5/16"	10.71	6.70	5.52	3.32	Ø¾" x 26"	Ø10"
4"	14'	W - 5/16"	9.64	5.95	4.88	2.90	Ø¾" x 26"	Ø10"
4"	15'	W - 5/16"	8.69	5.28	4.31	2.52	Ø¾" x 26"	Ø10"
4"	16'	W - 5/16"	7.82	4.67	3.78	2.17	Ø¾" x 26"	Ø10"
4"	17'	W - 5/16"	7.04	4.11	3.30		Ø¾" x 26"	Ø10"
4"	18'	W - 5/16"	6.31	3.59	2.86		Ø¾" x 26"	Ø10"
4"	19'	W - 5/16"	5.64	3.10	2.45		Ø¾" x 26"	Ø10"
4"	20'	W - 5/16"	5.02	2.65	2.06		Ø¾" x 26"	Ø10"
4"	21'	W - 5/16"	4.43	2.23			Ø¾" x 26"	Ø10"
4"	22'	W - 5/16"	3.89				Ø¾" x 26"	Ø10"

MUFFLER POLE
EPA RATING TABLE - AASHTO

Aluminium
Fluted Shape - Q6 Muffler Base

Pole Dimension (in)	Height (ft)	Wall Thickness (in)	EPA Rating (sq.ft.)				Anchor Bolts (in)	Bolt Circle (in)
			90MPH	110MPH	120MPH	150MPH		
4"	10'	M - 3/16"	12.81	8.22	6.74	3.96	Ø¾" x 26"	Ø10"
4"	11'	M - 3/16"	11.03	6.97	5.66	3.21	Ø¾" x 26"	Ø10"
4"	12'	M - 3/16"	9.58	5.94	4.76	2.58	Ø¾" x 26"	Ø10"
4"	13'	M - 3/16"	8.36	5.07	4.00	2.03	Ø¾" x 26"	Ø10"
4"	14'	M - 3/16"	7.33	4.31	3.34		Ø¾" x 26"	Ø10"
4"	15'	M - 3/16"	6.43	3.65	2.75		Ø¾" x 26"	Ø10"
4"	16'	M - 3/16"	5.63	3.06	2.22		Ø¾" x 26"	Ø10"
4"	17'	M - 3/16"	4.92	2.52			Ø¾" x 26"	Ø10"
4"	18'	M - 3/16"	4.27	2.03			Ø¾" x 26"	Ø10"
4"	19'	M - 3/16"	3.68				Ø¾" x 26"	Ø10"
4"	20'	M - 3/16"	3.14				Ø¾" x 26"	Ø10"
4"	21'	M - 3/16"	2.63				Ø¾" x 26"	Ø10"
4"	22'	M - 3/16"	2.16				Ø¾" x 26"	Ø10"

Consult factory for reinforcement solutions for higher EPA ratings.

MUFFLER POLE
EPA RATING TABLE - AASHTO

Aluminium
Round Shape - Q8 Muffler Base

Pole Dimension (in)	Height (ft)	Wall Thickness (in)	EPA Rating (sq.ft.)				Anchor Bolts (in)	Bolt Circle (in)
			90MPH	110MPH	120MPH	150MPH		
4"	10'	L - 1/8"	9.32	5.89	4.78	2.71	Ø¾" x 26"	Ø11.5"
4"	11'	L - 1/8"	7.94	4.91	3.92	2.10	Ø¾" x 26"	Ø11.5"
4"	12'	L - 1/8"	6.81	4.09	3.21		Ø¾" x 26"	Ø11.5"
4"	13'	L - 1/8"	5.86	3.39	2.59		Ø¾" x 26"	Ø11.5"
4"	14'	L - 1/8"	5.04	2.78	2.05		Ø¾" x 26"	Ø11.5"
4"	15'	L - 1/8"	4.32	2.24			Ø¾" x 26"	Ø11.5"
4"	16'	L - 1/8"	3.67				Ø¾" x 26"	Ø11.5"
4"	17'	L - 1/8"	3.09				Ø¾" x 26"	Ø11.5"
4"	18'	L - 1/8"	2.57				Ø¾" x 26"	Ø11.5"
4"	19'	L - 1/8"	2.08				Ø¾" x 26"	Ø11.5"

4"	10'	M - 3/16"	13.79	8.88	7.29	4.32	Ø¾" x 26"	Ø11.5"
4"	11'	M - 3/16"	11.90	7.55	6.15	3.52	Ø¾" x 26"	Ø11.5"
4"	12'	M - 3/16"	10.35	6.46	5.20	2.86	Ø¾" x 26"	Ø11.5"
4"	13'	M - 3/16"	9.07	5.54	4.40	2.29	Ø¾" x 26"	Ø11.5"
4"	14'	M - 3/16"	7.97	4.75	3.70		Ø¾" x 26"	Ø11.5"
4"	15'	M - 3/16"	7.02	4.05	3.09		Ø¾" x 26"	Ø11.5"
4"	16'	M - 3/16"	6.18	3.43	2.53		Ø¾" x 26"	Ø11.5"
4"	17'	M - 3/16"	5.43	2.86	2.03		Ø¾" x 26"	Ø11.5"
4"	18'	M - 3/16"	4.75	2.35			Ø¾" x 26"	Ø11.5"
4"	19'	M - 3/16"	4.13				Ø¾" x 26"	Ø11.5"
4"	20'	M - 3/16"	3.56				Ø¾" x 26"	Ø11.5"
4"	21'	M - 3/16"	3.03				Ø¾" x 26"	Ø11.5"
4"	22'	M - 3/16"	2.54				Ø¾" x 26"	Ø11.5"

4"	10'	H - ¼"	17.82	11.58	9.56	5.77	Ø¾" x 26"	Ø11.5"
4"	11'	H - ¼"	15.46	9.94	8.15	4.81	Ø¾" x 26"	Ø11.5"
4"	12'	H - ¼"	13.55	8.60	7.00	4.01	Ø¾" x 26"	Ø11.5"
4"	13'	H - ¼"	11.97	7.48	6.03	3.33	Ø¾" x 26"	Ø11.5"
4"	14'	H - ¼"	10.62	6.52	5.19	2.73	Ø¾" x 26"	Ø11.5"
4"	15'	H - ¼"	9.46	5.68	4.46	2.20	Ø¾" x 26"	Ø11.5"
4"	16'	H - ¼"	8.44	4.94	3.81		Ø¾" x 26"	Ø11.5"
4"	17'	H - ¼"	7.54	4.27	3.22		Ø¾" x 26"	Ø11.5"
4"	18'	H - ¼"	6.72	3.67	2.68		Ø¾" x 26"	Ø11.5"
4"	19'	H - ¼"	5.99	3.11	2.19		Ø¾" x 26"	Ø11.5"
4"	20'	H - ¼"	5.31	2.60			Ø¾" x 26"	Ø11.5"
4"	21'	H - ¼"	4.69	2.13			Ø¾" x 26"	Ø11.5"
4"	22'	H - ¼"	4.11				Ø¾" x 26"	Ø11.5"

Consult factory for reinforcement solutions for higher EPA ratings.

MUFFLER POLE
EPA RATING TABLE - AASHTO

Aluminium
Round Shape - Q8 Muffler Base

Pole Dimension (in)	Height (ft)	Wall Thickness (in)	EPA Rating (sq.ft.)				Anchor Bolts (in)	Bolt Circle (in)
			90MPH	110MPH	120MPH	150MPH		
4"	10'	W - 5/16"	21.45	14.01	11.60	7.07	Ø¾" x 26"	Ø11.5"
4"	11'	W - 5/16"	18.67	12.09	9.96	5.96	Ø¾" x 26"	Ø11.5"
4"	12'	W - 5/16"	16.43	10.53	8.62	5.05	Ø¾" x 26"	Ø11.5"
4"	13'	W - 5/16"	14.58	9.23	7.50	4.27	Ø¾" x 26"	Ø11.5"
4"	14'	W - 5/16"	13.01	8.12	6.53	3.59	Ø¾" x 26"	Ø11.5"
4"	15'	W - 5/16"	11.66	7.15	5.70	3.00	Ø¾" x 26"	Ø11.5"
4"	16'	W - 5/16"	10.48	6.30	4.95	2.46	Ø¾" x 26"	Ø11.5"
4"	17'	W - 5/16"	9.43	5.54	4.29		Ø¾" x 26"	Ø11.5"
4"	18'	W - 5/16"	8.50	4.86	3.68		Ø¾" x 26"	Ø11.5"
4"	19'	W - 5/16"	7.66	4.23	3.13		Ø¾" x 26"	Ø11.5"
4"	20'	W - 5/16"	6.89	3.66	2.61		Ø¾" x 26"	Ø11.5"
4"	21'	W - 5/16"	6.18	3.12	2.14		Ø¾" x 26"	Ø11.5"
4"	22'	W - 5/16"	5.53	2.63			Ø¾" x 26"	Ø11.5"

5"	10'	L - 1/8"	15.20	9.74	8.01	4.99	Ø¾" x 26"	Ø11.5"
5"	11'	L - 1/8"	13.07	8.23	6.72	4.14	Ø¾" x 26"	Ø11.5"
5"	12'	L - 1/8"	11.33	7.00	5.65	3.43	Ø¾" x 26"	Ø11.5"
5"	13'	L - 1/8"	9.87	5.95	4.74	2.82	Ø¾" x 26"	Ø11.5"
5"	14'	L - 1/8"	8.63	5.04	3.94	2.29	Ø¾" x 26"	Ø11.5"
5"	15'	L - 1/8"	7.54	4.24	3.24		Ø¾" x 26"	Ø11.5"
5"	16'	L - 1/8"	6.58	3.52	2.61		Ø¾" x 26"	Ø11.5"
5"	17'	L - 1/8"	5.72	2.87	2.03		Ø¾" x 26"	Ø11.5"
5"	18'	L - 1/8"	4.94	2.27			Ø¾" x 26"	Ø11.5"
5"	19'	L - 1/8"	4.23				Ø¾" x 26"	Ø11.5"
5"	20'	L - 1/8"	3.57				Ø¾" x 26"	Ø11.5"
5"	21'	L - 1/8"	2.96				Ø¾" x 26"	Ø11.5"
5"	22'	L - 1/8"	2.38				Ø¾" x 26"	Ø11.5"

5"	10'	M - 3/16"	22.55	14.66	12.14	7.63	Ø¾" x 26"	Ø11.5"
5"	11'	M - 3/16"	19.57	12.59	10.38	6.48	Ø¾" x 26"	Ø11.5"
5"	12'	M - 3/16"	17.16	10.90	8.93	5.53	Ø¾" x 26"	Ø11.5"
5"	13'	M - 3/16"	15.16	9.48	7.71	4.72	Ø¾" x 26"	Ø11.5"
5"	14'	M - 3/16"	13.46	8.27	6.66	4.03	Ø¾" x 26"	Ø11.5"
5"	15'	M - 3/16"	11.99	7.21	5.74	3.42	Ø¾" x 26"	Ø11.5"
5"	16'	M - 3/16"	10.71	6.28	4.93	2.87	Ø¾" x 26"	Ø11.5"
5"	17'	M - 3/16"	9.56	5.44	4.19	2.38	Ø¾" x 26"	Ø11.5"
5"	18'	M - 3/16"	8.54	4.68	3.52		Ø¾" x 26"	Ø11.5"
5"	19'	M - 3/16"	7.61	3.98	2.91		Ø¾" x 26"	Ø11.5"
5"	20'	M - 3/16"	6.76	3.33	2.34		Ø¾" x 26"	Ø11.5"
5"	21'	M - 3/16"	5.98	2.73			Ø¾" x 26"	Ø11.5"
5"	22'	M - 3/16"	5.25	2.17			Ø¾" x 26"	Ø11.5"

Consult factory for reinforcement solutions for higher EPA ratings.

MUFFLER POLE
EPA RATING TABLE - AASHTO

Aluminium
Round Shape - Q8 Muffler Base

Pole Dimension (in)	Height (ft)	Wall Thickness (in)	EPA Rating (sq.ft.)				Anchor Bolts (in)	Bolt Circle (in)
			90 MPH	110 MPH	120 MPH	150 MPH		
5"	10'	H - 1/4"	29.32	19.19	15.95	10.07	Ø3/4" x 26"	Ø11.5"
5"	11'	H - 1/4"	25.56	16.60	13.74	8.63	Ø3/4" x 26"	Ø11.5"
5"	12'	H - 1/4"	22.53	14.49	11.95	7.46	Ø3/4" x 26"	Ø11.5"
5"	13'	H - 1/4"	20.02	12.74	10.45	6.47	Ø3/4" x 26"	Ø11.5"
5"	14'	H - 1/4"	17.91	11.25	9.16	5.63	Ø3/4" x 26"	Ø11.5"
5"	15'	H - 1/4"	16.09	9.96	8.05	4.89	Ø3/4" x 26"	Ø11.5"
5"	16'	H - 1/4"	14.50	8.82	7.06	4.24	Ø3/4" x 26"	Ø11.5"
5"	17'	H - 1/4"	13.10	7.81	6.18	3.65	Ø3/4" x 26"	Ø11.5"
5"	18'	H - 1/4"	11.85	6.89	5.39	3.12	Ø3/4" x 26"	Ø11.5"
5"	19'	H - 1/4"	10.72	6.06	4.66	2.63	Ø3/4" x 26"	Ø11.5"
5"	20'	H - 1/4"	9.70	5.30	3.99	2.17	Ø3/4" x 26"	Ø11.5"
5"	21'	H - 1/4"	8.76	4.59	3.37		Ø3/4" x 26"	Ø11.5"
5"	22'	H - 1/4"	7.89	3.94	2.78		Ø3/4" x 26"	Ø11.5"

5"	10'	W - 5/16"	35.57	23.37	19.47	12.32	Ø3/4" x 26"	Ø11.5"
5"	11'	W - 5/16"	31.08	20.29	16.85	10.62	Ø3/4" x 26"	Ø11.5"
5"	12'	W - 5/16"	27.48	17.81	14.73	9.24	Ø3/4" x 26"	Ø11.5"
5"	13'	W - 5/16"	24.51	15.74	12.97	8.09	Ø3/4" x 26"	Ø11.5"
5"	14'	W - 5/16"	22.01	14.00	11.47	7.11	Ø3/4" x 26"	Ø11.5"
5"	15'	W - 5/16"	19.87	12.49	10.17	6.25	Ø3/4" x 26"	Ø11.5"
5"	16'	W - 5/16"	18.01	11.16	9.03	5.50	Ø3/4" x 26"	Ø11.5"
5"	17'	W - 5/16"	16.37	9.99	8.02	4.83	Ø3/4" x 26"	Ø11.5"
5"	18'	W - 5/16"	14.91	8.94	7.11	4.22	Ø3/4" x 26"	Ø11.5"
5"	19'	W - 5/16"	13.60	7.99	6.27	3.66	Ø3/4" x 26"	Ø11.5"
5"	20'	W - 5/16"	12.41	7.11	5.51	3.15	Ø3/4" x 26"	Ø11.5"
5"	21'	W - 5/16"	11.32	6.31	4.81	2.68	Ø3/4" x 26"	Ø11.5"
5"	22'	W - 5/16"	10.32	5.57	4.15	2.23	Ø3/4" x 26"	Ø11.5"

Consult factory for reinforcement solutions for higher EPA ratings.

MUFFLER POLE
EPA RATING TABLE - AASHTO

Aluminium
Fluted Shape - Q8 Muffler Base

Pole Dimension (in)	Height (ft)	Wall Thickness (in)	EPA Rating (sq.ft.)				Anchor Bolts (in)	Bolt Circle (in)
			90 MPH	110 MPH	120 MPH	150 MPH		
4"	10'	M - 3/16"	12.81	8.22	6.74	3.96	Ø3/4" x 26"	Ø11.5"
4"	11'	M - 3/16"	11.03	6.97	5.66	3.21	Ø3/4" x 26"	Ø11.5"
4"	12'	M - 3/16"	9.58	5.94	4.76	2.58	Ø3/4" x 26"	Ø11.5"
4"	13'	M - 3/16"	8.36	5.07	4.00	2.03	Ø3/4" x 26"	Ø11.5"
4"	14'	M - 3/16"	7.33	4.31	3.34		Ø3/4" x 26"	Ø11.5"
4"	15'	M - 3/16"	6.43	3.65	2.75		Ø3/4" x 26"	Ø11.5"
4"	16'	M - 3/16"	5.63	3.06	2.22		Ø3/4" x 26"	Ø11.5"
4"	17'	M - 3/16"	4.92	2.52			Ø3/4" x 26"	Ø11.5"
4"	18'	M - 3/16"	4.27	2.03			Ø3/4" x 26"	Ø11.5"
4"	19'	M - 3/16"	3.68				Ø3/4" x 26"	Ø11.5"
4"	20'	M - 3/16"	3.14				Ø3/4" x 26"	Ø11.5"
4"	21'	M - 3/16"	2.63				Ø3/4" x 26"	Ø11.5"
4"	22'	M - 3/16"	2.16				Ø3/4" x 26"	Ø11.5"

5"	10'	M - 3/16"	26.12	17.05	14.15	8.92	Ø3/4" x 26"	Ø11.5"
5"	11'	M - 3/16"	22.73	14.70	12.15	7.62	Ø3/4" x 26"	Ø11.5"
5"	12'	M - 3/16"	19.99	12.79	10.52	6.55	Ø3/4" x 26"	Ø11.5"
5"	13'	M - 3/16"	17.72	11.20	9.15	5.65	Ø3/4" x 26"	Ø11.5"
5"	14'	M - 3/16"	15.81	9.84	7.98	4.87	Ø3/4" x 26"	Ø11.5"
5"	15'	M - 3/16"	14.15	8.66	6.96	4.20	Ø3/4" x 26"	Ø11.5"
5"	16'	M - 3/16"	12.71	7.62	6.05	3.59	Ø3/4" x 26"	Ø11.5"
5"	17'	M - 3/16"	11.43	6.69	5.24	3.05	Ø3/4" x 26"	Ø11.5"
5"	18'	M - 3/16"	10.29	5.85	4.51	2.55	Ø3/4" x 26"	Ø11.5"
5"	19'	M - 3/16"	9.25	5.08	3.83	2.10	Ø3/4" x 26"	Ø11.5"
5"	20'	M - 3/16"	8.31	4.37	3.21		Ø3/4" x 26"	Ø11.5"
5"	21'	M - 3/16"	7.44	3.72	2.63		Ø3/4" x 26"	Ø11.5"
5"	22'	M - 3/16"	6.64	3.10	2.08		Ø3/4" x 26"	Ø11.5"

Consult factory for reinforcement solutions for higher EPA ratings.

MUFFLER POLE
EPA RATING TABLE - AASHTO

Steel
Round Shape - Q6 Muffler Base

Pole Dimension (in)	Height (ft)	Wall Thickness (in)	EPA Rating (sq.ft.)				Anchor Bolts (in)	Bolt Circle (in)
			90MPH	110MPH	120MPH	150MPH		
4"	10'	L - 1/8"	26.70	17.25	14.19	8.45	Ø¾" x 26"	Ø10"
4"	11'	L - 1/8"	23.76	15.22	12.45	7.28	Ø¾" x 26"	Ø10"
4"	12'	L - 1/8"	21.30	13.51	10.99	6.28	Ø¾" x 26"	Ø10"
4"	13'	L - 1/8"	19.20	12.04	9.73	5.41	Ø¾" x 26"	Ø10"
4"	14'	L - 1/8"	17.38	10.76	8.62	4.65	Ø¾" x 26"	Ø10"
4"	15'	L - 1/8"	15.78	9.63	7.64	3.96	Ø¾" x 26"	Ø10"
4"	16'	L - 1/8"	14.36	8.62	6.76	3.33	Ø¾" x 26"	Ø10"
4"	17'	L - 1/8"	13.08	7.70	5.96	2.76	Ø¾" x 26"	Ø10"
4"	18'	L - 1/8"	11.93	6.87	5.23	2.23	Ø¾" x 26"	Ø10"
4"	19'	L - 1/8"	10.88	6.10	4.56		Ø¾" x 26"	Ø10"
4"	20'	L - 1/8"	9.91	5.39	3.93		Ø¾" x 26"	Ø10"
4"	21'	L - 1/8"	9.01	4.73	3.34		Ø¾" x 26"	Ø10"
4"	22'	L - 1/8"	8.17	4.11	2.79		Ø¾" x 26"	Ø10"

4"	10'	M - 3/16"	26.70	17.25	14.19	8.45	Ø¾" x 26"	Ø10"
4"	11'	M - 3/16"	23.76	15.22	12.45	7.28	Ø¾" x 26"	Ø10"
4"	12'	M - 3/16"	21.30	13.51	10.99	6.28	Ø¾" x 26"	Ø10"
4"	13'	M - 3/16"	19.20	12.04	9.73	5.41	Ø¾" x 26"	Ø10"
4"	14'	M - 3/16"	17.38	10.76	8.62	4.65	Ø¾" x 26"	Ø10"
4"	15'	M - 3/16"	15.78	9.63	7.64	3.96	Ø¾" x 26"	Ø10"
4"	16'	M - 3/16"	14.36	8.62	6.76	3.33	Ø¾" x 26"	Ø10"
4"	17'	M - 3/16"	13.08	7.70	5.96	2.76	Ø¾" x 26"	Ø10"
4"	18'	M - 3/16"	11.93	6.87	5.23	2.23	Ø¾" x 26"	Ø10"
4"	19'	M - 3/16"	10.88	6.10	4.56		Ø¾" x 26"	Ø10"
4"	20'	M - 3/16"	9.91	5.39	3.93		Ø¾" x 26"	Ø10"
4"	21'	M - 3/16"	9.01	4.73	3.34		Ø¾" x 26"	Ø10"
4"	22'	M - 3/16"	8.17	4.11	2.79		Ø¾" x 26"	Ø10"

4"	10'	H - ¼"	26.70	17.25	14.19	8.45	Ø¾" x 26"	Ø10"
4"	11'	H - ¼"	23.76	15.22	12.45	7.28	Ø¾" x 26"	Ø10"
4"	12'	H - ¼"	21.30	13.51	10.99	6.28	Ø¾" x 26"	Ø10"
4"	13'	H - ¼"	19.20	12.04	9.73	5.41	Ø¾" x 26"	Ø10"
4"	14'	H - ¼"	17.38	10.76	8.62	4.65	Ø¾" x 26"	Ø10"
4"	15'	H - ¼"	15.78	9.63	7.64	3.96	Ø¾" x 26"	Ø10"
4"	16'	H - ¼"	14.36	8.62	6.76	3.33	Ø¾" x 26"	Ø10"
4"	17'	H - ¼"	13.08	7.70	5.96	2.76	Ø¾" x 26"	Ø10"
4"	18'	H - ¼"	11.93	6.87	5.23	2.23	Ø¾" x 26"	Ø10"
4"	19'	H - ¼"	10.88	6.10	4.56		Ø¾" x 26"	Ø10"
4"	20'	H - ¼"	9.91	5.39	3.93		Ø¾" x 26"	Ø10"
4"	21'	H - ¼"	9.01	4.73	3.34		Ø¾" x 26"	Ø10"
4"	22'	H - ¼"	8.17	4.11	2.79		Ø¾" x 26"	Ø10"

Consult factory for reinforcement solutions for higher EPA ratings.

MUFFLER POLE
EPA RATING TABLE - AASHTO

Steel
Round Shape - Q6 Muffler Base

Pole Dimension (in)	Height (ft)	Wall Thickness (in)	EPA Rating (sq.ft.)				Anchor Bolts (in)	Bolt Circle (in)
			90MPH	110MPH	120MPH	150MPH		
4"	10'	W - 5/16"	26.70	17.25	14.19	8.45	Ø¾" x 26"	Ø10"
4"	11'	W - 5/16"	23.76	15.22	12.45	7.28	Ø¾" x 26"	Ø10"
4"	12'	W - 5/16"	21.30	13.51	10.99	6.28	Ø¾" x 26"	Ø10"
4"	13'	W - 5/16"	19.20	12.04	9.73	5.41	Ø¾" x 26"	Ø10"
4"	14'	W - 5/16"	17.38	10.76	8.62	4.65	Ø¾" x 26"	Ø10"
4"	15'	W - 5/16"	15.78	9.63	7.64	3.96	Ø¾" x 26"	Ø10"
4"	16'	W - 5/16"	14.36	8.62	6.76	3.33	Ø¾" x 26"	Ø10"
4"	17'	W - 5/16"	13.08	7.70	5.96	2.76	Ø¾" x 26"	Ø10"
4"	18'	W - 5/16"	11.93	6.87	5.23	2.23	Ø¾" x 26"	Ø10"
4"	19'	W - 5/16"	10.88	6.10	4.56		Ø¾" x 26"	Ø10"
4"	20'	W - 5/16"	9.91	5.39	3.93		Ø¾" x 26"	Ø10"
4"	21'	W - 5/16"	9.01	4.73	3.34		Ø¾" x 26"	Ø10"
4"	22'	W - 5/16"	8.17	4.11	2.79		Ø¾" x 26"	Ø10"

Consult factory for reinforcement solutions for higher EPA ratings.

MUFFLER POLE
EPA RATING TABLE - AASHTO

Steel
Round Shape - Q8 Muffler Base

Pole Dimension (in)	Height (ft)	Wall Thickness (in)	EPA Rating (sq.ft.)				Anchor Bolts (in)	Bolt Circle (in)
			90MPH	110MPH	120MPH	150MPH		
4"	10'	L-1/8"	32.57	21.44	17.84	11.06	Ø1" x 36"	Ø11.5"
4"	11'	L-1/8"	28.54	18.68	15.50	9.50	Ø1" x 36"	Ø11.5"
4"	12'	L-1/8"	25.29	16.45	13.59	8.22	Ø1" x 36"	Ø11.5"
4"	13'	L-1/8"	22.59	14.58	11.99	7.14	Ø1" x 36"	Ø11.5"
4"	14'	L-1/8"	20.32	13.00	10.63	6.21	Ø1" x 36"	Ø11.5"
4"	15'	L-1/8"	18.36	11.63	9.45	5.39	Ø1" x 36"	Ø11.5"
4"	16'	L-1/8"	16.65	10.43	8.41	4.66	Ø1" x 36"	Ø11.5"
4"	17'	L-1/8"	15.14	9.36	7.48	4.01	Ø1" x 36"	Ø11.5"
4"	18'	L-1/8"	13.80	8.39	6.65	3.41	Ø1" x 36"	Ø11.5"
4"	19'	L-1/8"	12.58	7.52	5.88	2.86	Ø1" x 36"	Ø11.5"
4"	20'	L-1/8"	11.47	6.72	5.18	2.35	Ø1" x 36"	Ø11.5"
4"	21'	L-1/8"	10.46	5.98	4.53		Ø1" x 36"	Ø11.5"
4"	22'	L-1/8"	9.52	5.29	3.92		Ø1" x 36"	Ø11.5"

4"	10'	M-3/16"	40.00	31.15	26.00	16.28	Ø1" x 36"	Ø11.5"
4"	11'	M-3/16"	40.00	27.29	22.72	14.12	Ø1" x 36"	Ø11.5"
4"	12'	M-3/16"	36.82	24.17	20.07	12.37	Ø1" x 36"	Ø11.5"
4"	13'	M-3/16"	33.05	21.58	17.87	10.90	Ø1" x 36"	Ø11.5"
4"	14'	M-3/16"	29.88	19.40	16.01	9.65	Ø1" x 36"	Ø11.5"
4"	15'	M-3/16"	27.16	17.52	14.40	8.56	Ø1" x 36"	Ø11.5"
4"	16'	M-3/16"	24.80	15.88	12.99	7.60	Ø1" x 36"	Ø11.5"
4"	17'	M-3/16"	22.72	14.43	11.75	6.74	Ø1" x 36"	Ø11.5"
4"	18'	M-3/16"	20.88	13.13	10.63	5.96	Ø1" x 36"	Ø11.5"
4"	19'	M-3/16"	19.22	11.96	9.62	5.25	Ø1" x 36"	Ø11.5"
4"	20'	M-3/16"	17.72	10.90	8.69	4.60	Ø1" x 36"	Ø11.5"
4"	21'	M-3/16"	16.35	9.92	7.84	4.00	Ø1" x 36"	Ø11.5"
4"	22'	M-3/16"	15.08	9.01	7.05	3.43	Ø1" x 36"	Ø11.5"

4"	10'	H-1/4"	40.00	39.91	33.36	20.99	Ø1" x 36"	Ø11.5"
4"	11'	H-1/4"	40.00	35.05	29.25	18.30	Ø1" x 36"	Ø11.5"
4"	12'	H-1/4"	40.00	31.13	25.93	16.11	Ø1" x 36"	Ø11.5"
4"	13'	H-1/4"	40.00	27.90	23.18	14.30	Ø1" x 36"	Ø11.5"
4"	14'	H-1/4"	38.50	25.17	20.86	12.75	Ø1" x 36"	Ø11.5"
4"	15'	H-1/4"	35.09	22.83	18.87	11.41	Ø1" x 36"	Ø11.5"
4"	16'	H-1/4"	32.14	20.80	17.13	10.24	Ø1" x 36"	Ø11.5"
4"	17'	H-1/4"	29.56	19.00	15.59	9.20	Ø1" x 36"	Ø11.5"
4"	18'	H-1/4"	27.26	17.41	14.22	8.26	Ø1" x 36"	Ø11.5"
4"	19'	H-1/4"	25.20	15.97	12.98	7.41	Ø1" x 36"	Ø11.5"
4"	20'	H-1/4"	23.34	14.66	11.86	6.63	Ø1" x 36"	Ø11.5"
4"	21'	H-1/4"	21.65	13.47	10.82	5.91	Ø1" x 36"	Ø11.5"
4"	22'	H-1/4"	20.09	12.37	9.87	5.24	Ø1" x 36"	Ø11.5"

Consult factory for reinforcement solutions for higher EPA ratings.

MUFFLER POLE
EPA RATING TABLE - AASHTO

Steel
Round Shape - Q8 Muffler Base

Pole Dimension (in)	Height (ft)	Wall Thickness (in)	EPA Rating (sq.ft.)				Anchor Bolts (in)	Bolt Circle (in)
			90MPH	110MPH	120MPH	150MPH		
4"	10'	W-5/16"	40.00	40.00	39.99	25.23	Ø1" x 36"	Ø11.5"
4"	11'	W-5/16"	40.00	40.00	35.12	22.06	Ø1" x 36"	Ø11.5"
4"	12'	W-5/16"	40.00	37.40	31.20	19.49	Ø1" x 36"	Ø11.5"
4"	13'	W-5/16"	40.00	33.58	27.96	17.35	Ø1" x 36"	Ø11.5"
4"	14'	W-5/16"	40.00	30.37	25.23	15.55	Ø1" x 36"	Ø11.5"
4"	15'	W-5/16"	40.00	27.61	22.88	13.99	Ø1" x 36"	Ø11.5"
4"	16'	W-5/16"	38.76	25.22	20.85	12.62	Ø1" x 36"	Ø11.5"
4"	17'	W-5/16"	35.70	23.12	19.05	11.41	Ø1" x 36"	Ø11.5"
4"	18'	W-5/16"	33.00	21.25	17.45	10.33	Ø1" x 36"	Ø11.5"
4"	19'	W-5/16"	30.58	19.57	16.01	9.35	Ø1" x 36"	Ø11.5"
4"	20'	W-5/16"	28.40	18.05	14.70	8.45	Ø1" x 36"	Ø11.5"
4"	21'	W-5/16"	26.41	16.66	13.50	7.62	Ø1" x 36"	Ø11.5"
4"	22'	W-5/16"	24.59	15.38	12.40	6.86	Ø1" x 36"	Ø11.5"

5"	10'	L-1/8"	40.00	34.55	28.85	18.32	Ø1" x 36"	Ø11.5"
5"	11'	L-1/8"	40.00	30.23	25.20	15.96	Ø1" x 36"	Ø11.5"
5"	12'	L-1/8"	40.85	26.75	22.24	14.04	Ø1" x 36"	Ø11.5"
5"	13'	L-1/8"	36.65	23.85	19.78	12.44	Ø1" x 36"	Ø11.5"
5"	14'	L-1/8"	33.10	21.41	17.70	11.09	Ø1" x 36"	Ø11.5"
5"	15'	L-1/8"	30.07	19.31	15.90	9.91	Ø1" x 36"	Ø11.5"
5"	16'	L-1/8"	27.44	17.47	14.33	8.88	Ø1" x 36"	Ø11.5"
5"	17'	L-1/8"	25.13	15.84	12.93	7.97	Ø1" x 36"	Ø11.5"
5"	18'	L-1/8"	23.07	14.39	11.68	7.14	Ø1" x 36"	Ø11.5"
5"	19'	L-1/8"	21.22	13.08	10.55	6.39	Ø1" x 36"	Ø11.5"
5"	20'	L-1/8"	19.55	11.88	9.51	5.71	Ø1" x 36"	Ø11.5"
5"	21'	L-1/8"	18.02	10.79	8.56	5.07	Ø1" x 36"	Ø11.5"
5"	22'	L-1/8"	16.62	9.77	7.68	4.49	Ø1" x 36"	Ø11.5"
5"	23'	L-1/8"	15.33	8.83	6.86	3.94	Ø1" x 36"	Ø11.5"
5"	24'	L-1/8"	14.12	7.95	6.09	3.42	Ø1" x 36"	Ø11.5"
5"	25'	L-1/8"	13.00	7.12	5.36	2.93	Ø1" x 36"	Ø11.5"
5"	26'	L-1/8"	11.94	6.33	4.68	2.47	Ø1" x 36"	Ø11.5"
5"	27'	L-1/8"	10.94	5.59	4.02	2.02	Ø1" x 36"	Ø11.5"
5"	28'	L-1/8"	10.00	4.88	3.40		Ø1" x 36"	Ø11.5"
5"	29'	L-1/8"	9.10	4.21	2.80		Ø1" x 36"	Ø11.5"
5"	30'	L-1/8"	8.24	3.56	2.23		Ø1" x 36"	Ø11.5"

Consult factory for reinforcement solutions for higher EPA ratings.

MUFFLER POLE
EPA RATING TABLE - AASHTO

Steel
Round Shape - Q8 Muffler Base

Pole Dimension (in)	Height (ft)	Wall Thickness (in)	EPA Rating (sq.ft.)				Anchor Bolts (in)	Bolt Circle (in)
			90MPH	110MPH	120MPH	150MPH		
5"	10'	M - 3/16"	40.00	40.00	40.00	26.92	Ø1" x 36"	Ø11.5"
5"	11'	M - 3/16"	40.00	40.00	37.10	23.58	Ø1" x 36"	Ø11.5"
5"	12'	M - 3/16"	40.00	39.46	32.93	20.88	Ø1" x 36"	Ø11.5"
5"	13'	M - 3/16"	40.00	35.39	29.47	18.65	Ø1" x 36"	Ø11.5"
5"	14'	M - 3/16"	40.00	31.96	26.56	16.76	Ø1" x 36"	Ø11.5"
5"	15'	M - 3/16"	40.00	29.02	24.07	15.14	Ø1" x 36"	Ø11.5"
5"	16'	M - 3/16"	40.89	26.47	21.89	13.73	Ø1" x 36"	Ø11.5"
5"	17'	M - 3/16"	37.65	24.23	19.98	12.48	Ø1" x 36"	Ø11.5"
5"	18'	M - 3/16"	34.78	22.23	18.27	11.36	Ø1" x 36"	Ø11.5"
5"	19'	M - 3/16"	32.22	20.44	16.73	10.35	Ø1" x 36"	Ø11.5"
5"	20'	M - 3/16"	29.91	18.82	15.34	9.44	Ø1" x 36"	Ø11.5"
5"	21'	M - 3/16"	27.81	17.34	14.07	8.60	Ø1" x 36"	Ø11.5"
5"	22'	M - 3/16"	25.89	15.97	12.89	7.82	Ø1" x 36"	Ø11.5"
5"	23'	M - 3/16"	24.12	14.71	11.81	7.10	Ø1" x 36"	Ø11.5"
5"	24'	M - 3/16"	22.48	13.54	10.79	6.43	Ø1" x 36"	Ø11.5"
5"	25'	M - 3/16"	20.96	12.45	9.84	5.80	Ø1" x 36"	Ø11.5"
5"	26'	M - 3/16"	19.54	11.42	8.95	5.20	Ø1" x 36"	Ø11.5"
5"	27'	M - 3/16"	18.20	10.45	8.10	4.64	Ø1" x 36"	Ø11.5"
5"	28'	M - 3/16"	16.94	9.53	7.30	4.10	Ø1" x 36"	Ø11.5"
5"	29'	M - 3/16"	15.75	8.66	6.54	3.59	Ø1" x 36"	Ø11.5"
5"	30'	M - 3/16"	14.61	7.82	5.81	3.10	Ø1" x 36"	Ø11.5"

5"	10'	H - ¼"	40.00	40.00	40.00	31.14	Ø1" x 36"	Ø11.5"
5"	11'	H - ¼"	40.00	40.00	40.00	27.82	Ø1" x 36"	Ø11.5"
5"	12'	H - ¼"	40.00	40.00	39.63	25.05	Ø1" x 36"	Ø11.5"
5"	13'	H - ¼"	40.00	40.00	35.98	22.69	Ø1" x 36"	Ø11.5"
5"	14'	H - ¼"	40.00	39.61	32.84	20.65	Ø1" x 36"	Ø11.5"
5"	15'	H - ¼"	40.00	36.39	30.10	18.88	Ø1" x 36"	Ø11.5"
5"	16'	H - ¼"	40.00	33.54	27.68	17.30	Ø1" x 36"	Ø11.5"
5"	17'	H - ¼"	40.00	31.01	25.52	15.90	Ø1" x 36"	Ø11.5"
5"	18'	H - ¼"	40.00	28.74	23.59	14.63	Ø1" x 36"	Ø11.5"
5"	19'	H - ¼"	40.00	26.69	21.83	13.49	Ø1" x 36"	Ø11.5"
5"	20'	H - ¼"	39.44	24.82	20.23	12.44	Ø1" x 36"	Ø11.5"
5"	21'	H - ¼"	36.81	23.11	18.76	11.48	Ø1" x 36"	Ø11.5"
5"	22'	H - ¼"	34.41	21.53	17.41	10.58	Ø1" x 36"	Ø11.5"
5"	23'	H - ¼"	32.21	20.07	16.15	9.75	Ø1" x 36"	Ø11.5"
5"	24'	H - ¼"	30.17	18.69	14.98	8.98	Ø1" x 36"	Ø11.5"
5"	25'	H - ¼"	28.28	17.35	13.88	8.25	Ø1" x 36"	Ø11.5"
5"	26'	H - ¼"	26.52	16.10	12.85	7.57	Ø1" x 36"	Ø11.5"
5"	27'	H - ¼"	24.87	14.92	11.86	6.92	Ø1" x 36"	Ø11.5"
5"	28'	H - ¼"	23.32	13.80	10.89	6.31	Ø1" x 36"	Ø11.5"
5"	29'	H - ¼"	21.85	12.74	9.97	5.73	Ø1" x 36"	Ø11.5"
5"	30'	H - ¼"	20.46	11.74	9.10	5.17	Ø1" x 36"	Ø11.5"

Consult factory for reinforcement solutions for higher EPA ratings.

MUFFLER POLE
EPA RATING TABLE - AASHTO

Steel
Round Shape - Q8 Muffler Base

Pole Dimension (in)	Height (ft)	Wall Thickness (in)	EPA Rating (sq.ft.)				Anchor Bolts (in)	Bolt Circle (in)
			90MPH	110MPH	120MPH	150MPH		
5"	10'	W - 5/16"	40.00	40.00	40.00	31.14	Ø1" x 36"	Ø11.5"
5"	11'	W - 5/16"	40.00	40.00	40.00	27.82	Ø1" x 36"	Ø11.5"
5"	12'	W - 5/16"	40.00	40.00	39.63	25.05	Ø1" x 36"	Ø11.5"
5"	13'	W - 5/16"	40.00	40.00	35.98	22.69	Ø1" x 36"	Ø11.5"
5"	14'	W - 5/16"	40.00	39.61	32.84	20.65	Ø1" x 36"	Ø11.5"
5"	15'	W - 5/16"	40.00	36.39	30.10	18.88	Ø1" x 36"	Ø11.5"
5"	16'	W - 5/16"	40.00	33.54	27.68	17.30	Ø1" x 36"	Ø11.5"
5"	17'	W - 5/16"	40.00	31.01	25.52	15.90	Ø1" x 36"	Ø11.5"
5"	18'	W - 5/16"	40.00	28.74	23.59	14.63	Ø1" x 36"	Ø11.5"
5"	19'	W - 5/16"	40.00	26.69	21.83	13.49	Ø1" x 36"	Ø11.5"
5"	20'	W - 5/16"	39.47	24.82	20.23	12.44	Ø1" x 36"	Ø11.5"
5"	21'	W - 5/16"	37.03	23.11	18.76	11.48	Ø1" x 36"	Ø11.5"
5"	22'	W - 5/16"	34.79	21.53	17.41	10.58	Ø1" x 36"	Ø11.5"
5"	23'	W - 5/16"	32.72	20.07	16.15	9.75	Ø1" x 36"	Ø11.5"
5"	24'	W - 5/16"	30.80	18.71	14.98	8.98	Ø1" x 36"	Ø11.5"
5"	25'	W - 5/16"	29.02	17.44	13.88	8.25	Ø1" x 36"	Ø11.5"
5"	26'	W - 5/16"	27.35	16.25	12.85	7.57	Ø1" x 36"	Ø11.5"
5"	27'	W - 5/16"	25.79	15.13	11.88	6.92	Ø1" x 36"	Ø11.5"
5"	28'	W - 5/16"	24.32	14.07	10.95	6.31	Ø1" x 36"	Ø11.5"
5"	29'	W - 5/16"	22.93	13.06	10.08	5.73	Ø1" x 36"	Ø11.5"
5"	30'	W - 5/16"	21.61	12.10	9.25	5.17	Ø1" x 36"	Ø11.5"

Consult factory for reinforcement solutions for higher EPA ratings.





LUMENTECH SMART POLE

TECHNICAL INFORMATION

Lumentech Smart Pole

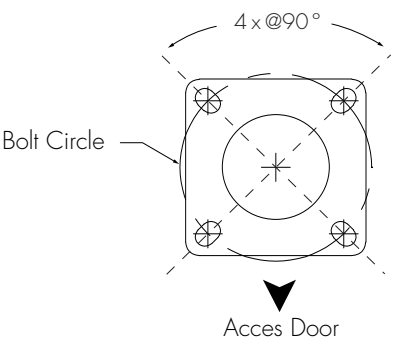
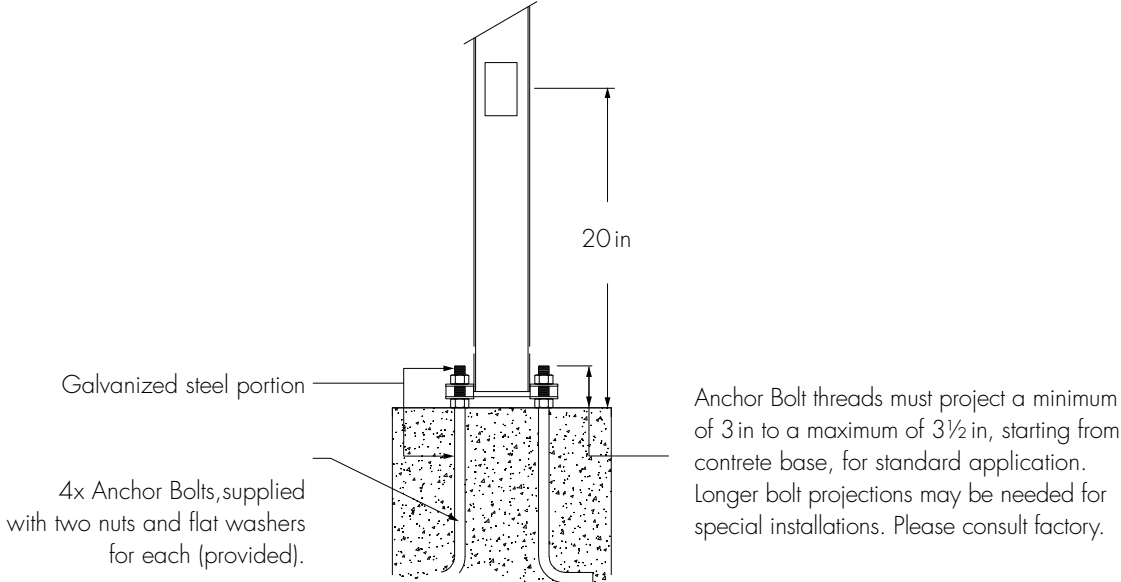
Technical Information

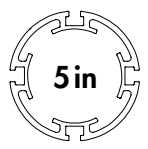
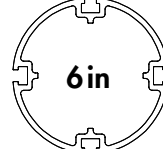

	Round Shapes		
	 5 in	 6 in	 8 in
Compatible Base Cover Options	WA, WC, WF, WH, WI, WJ, WL, WM, WO, WP, WR, WS, WY, WYX	SB, WL, WO,	SB, SC
Compatible Accessories	HK, SSK, LSK, PG PLTU, SSH, LRTR-5, LHTR-5	HK, SSK, LSK, PG PLTU, SSH, LRTR-6, LHTR-6	HK, SSK, LSK, PG PLTU, SSH, LRTR-8, LHTR-8
Anchor Bolts	Ø3/4 in x 26 in	Ø1 in x 36 in	
Bolt Circle	Ø10 in	Ø14 in	

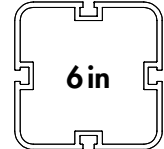
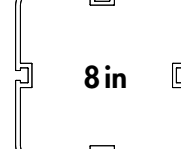
	Square Shapes	
	 6 in	 8 in
	SB	SB, SC
	HK, SSK, LSK, PG PLTU, SSH, LRTR-8, LHTR-8	
	Ø1 in x 36 in	
	Ø14 in	

Lumentech Smart Pole

Technical Information

Base Cover Options

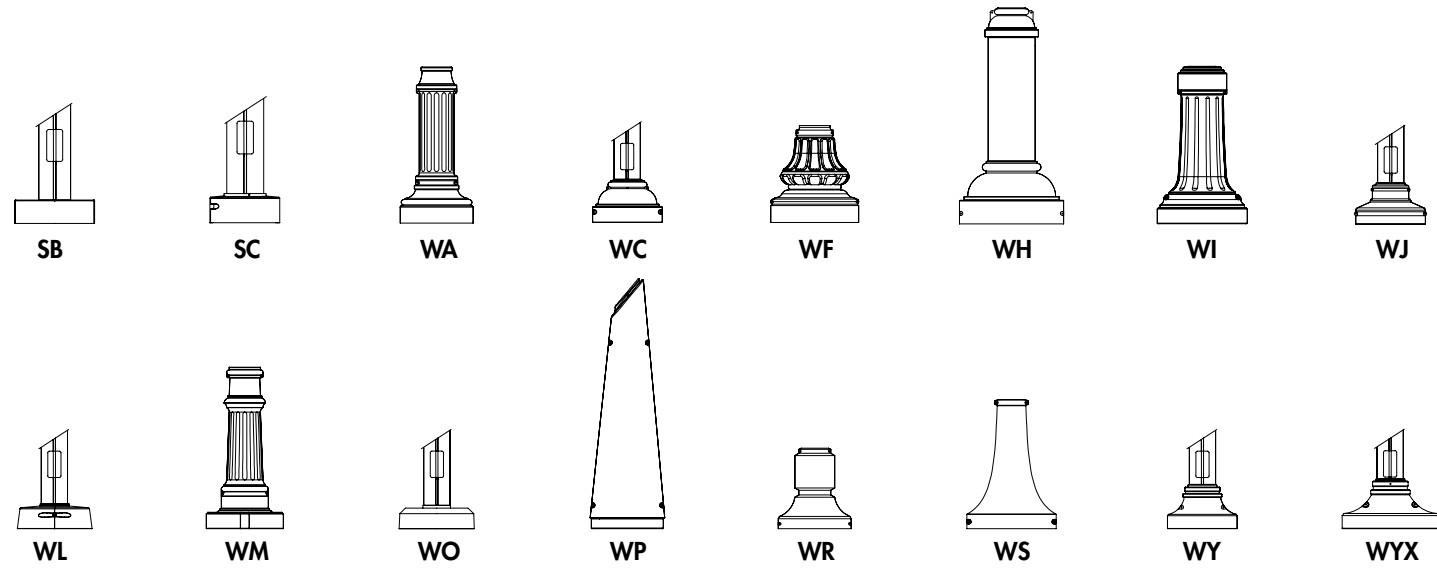

Accessories

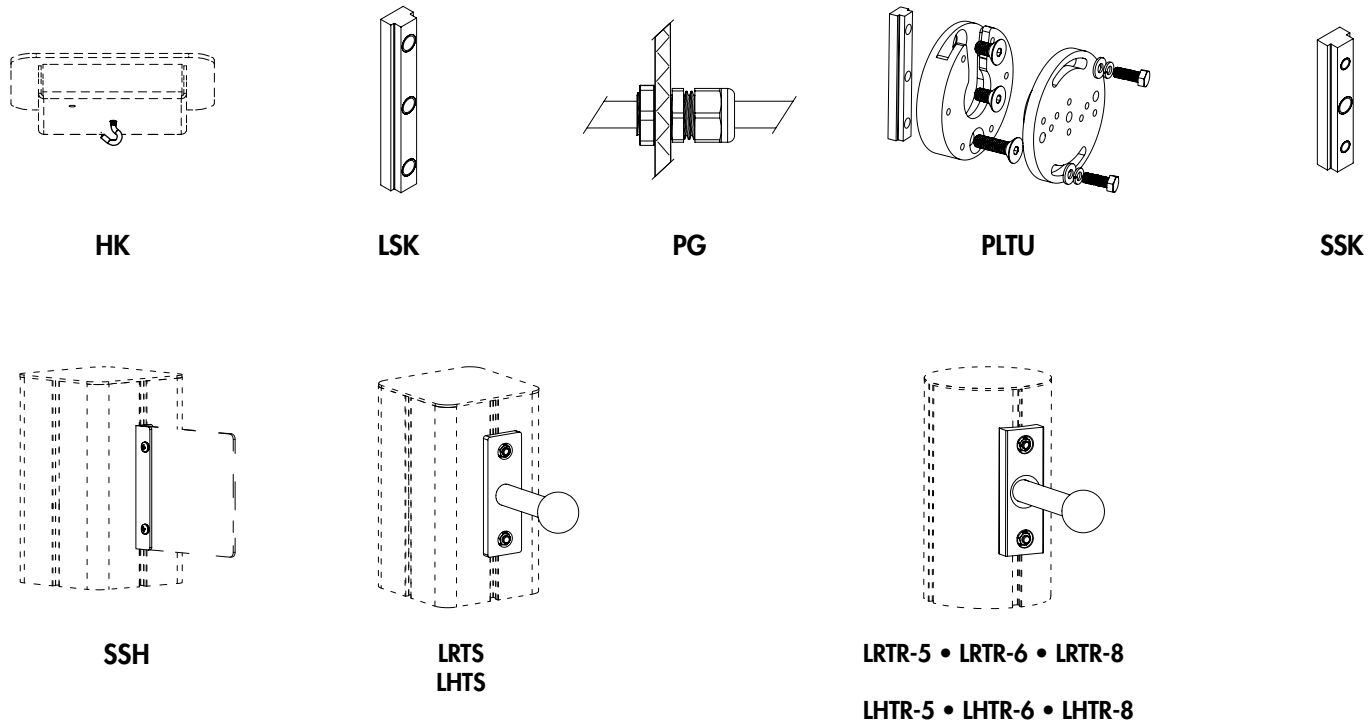

Pole-Top Options

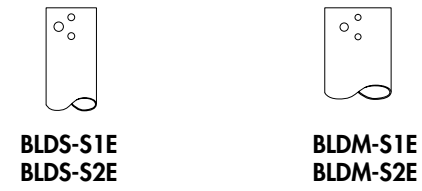

Other Options

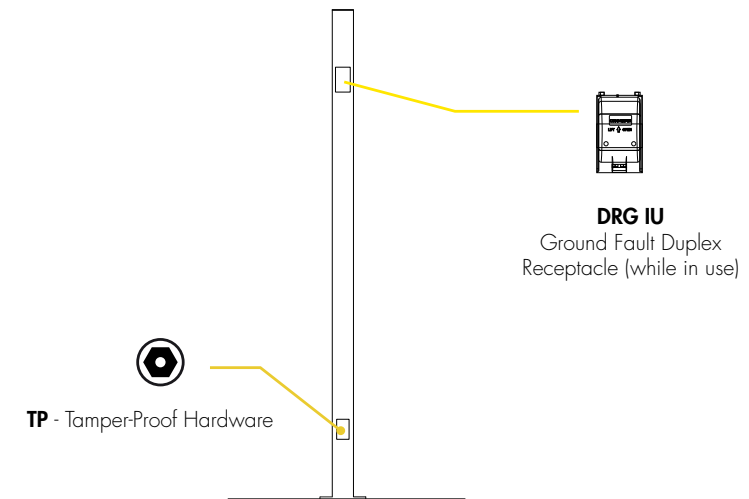

Finish Options



[1] Automatically included when a steel pole is specified

LUMENTECH SMART POLE

EPA RATING TABLE - AASHTO

LUMENTECH SMART POLE
EPA RATING TABLE - AASHTO

Round Shape

Dimension (in)	Height (ft)	EPA Rating (sq.ft.)				Anchor Bolts (in)	Bolt Circle (in)
		90 MPH	110 MPH	120 MPH	150 MPH		
5"	10'	20.89	13.30	10.90	6.76	Ø¾" x 26"	Ø10"
5"	11'	18.75	11.79	9.61	5.91	Ø¾" x 26"	Ø10"
5"	12'	16.90	10.48	8.47	5.16	Ø¾" x 26"	Ø10"
5"	13'	15.29	9.32	7.47	4.49	Ø¾" x 26"	Ø10"
5"	14'	13.85	8.28	6.57	3.89	Ø¾" x 26"	Ø10"
5"	15'	12.57	7.35	5.76	3.35	Ø¾" x 26"	Ø10"
5"	16'	11.42	6.50	5.02	2.85	Ø¾" x 26"	Ø10"
5"	17'	10.36	5.72	4.33	2.39	Ø¾" x 26"	Ø10"
5"	18'	9.39	5.00	3.69		Ø¾" x 26"	Ø10"
5"	19'	8.50	4.32	3.10		Ø¾" x 26"	Ø10"
5"	20'	7.67	3.69	2.54		Ø¾" x 26"	Ø10"
5"	21'	6.89	3.10	2.01		Ø¾" x 26"	Ø10"
5"	22'	6.17	2.53			Ø¾" x 26"	Ø10"
5"	23'	5.48				Ø¾" x 26"	Ø10"
5"	24'	4.83				Ø¾" x 26"	Ø10"
5"	25'	4.21				Ø¾" x 26"	Ø10"
5"	26'	3.62				Ø¾" x 26"	Ø10"
5"	27'	3.06				Ø¾" x 26"	Ø10"
5"	28'	2.52				Ø¾" x 26"	Ø10"

6"	10'	30.34	19.85	16.56	10.39	Ø1" x 36"	Ø14"
6"	11'	27.33	17.78	14.81	9.25	Ø1" x 36"	Ø14"
6"	12'	24.74	15.99	13.30	8.26	Ø1" x 36"	Ø14"
6"	13'	22.49	14.43	11.98	7.39	Ø1" x 36"	Ø14"
6"	14'	20.49	13.05	10.80	6.61	Ø1" x 36"	Ø14"
6"	15'	18.71	11.80	9.74	5.92	Ø1" x 36"	Ø14"
6"	16'	17.11	10.68	8.79	5.28	Ø1" x 36"	Ø14"
6"	17'	15.66	9.65	7.91	4.70	Ø1" x 36"	Ø14"
6"	18'	14.33	8.71	7.11	4.16	Ø1" x 36"	Ø14"
6"	19'	13.10	7.84	6.36	3.66	Ø1" x 36"	Ø14"
6"	20'	11.97	7.03	5.67	3.20	Ø1" x 36"	Ø14"
6"	21'	10.91	6.27	5.02	2.76	Ø1" x 36"	Ø14"
6"	22'	9.92	5.56	4.41	2.34	Ø1" x 36"	Ø14"
6"	23'	8.99	4.89	3.83		Ø1" x 36"	Ø14"
6"	24'	8.12	4.25	3.28		Ø1" x 36"	Ø14"
6"	25'	7.28	3.64	2.76		Ø1" x 36"	Ø14"
6"	26'	6.50	3.06	2.26		Ø1" x 36"	Ø14"
6"	27'	5.74	2.51			Ø1" x 36"	Ø14"
6"	28'	5.02				Ø1" x 36"	Ø14"

Consult factory for internal reinforcement solutions for higher EPA ratings.

LUMENTECH SMART POLE
EPA RATING TABLE - AASHTO

Round Shape

Dimension (in)	Height (ft)	EPA Rating (sq.ft.)				Anchor Bolts (in)	Bolt Circle (in)
		90 MPH	110 MPH	120 MPH	150 MPH		
8"	10'	40.00	35.73	29.92	18.96	Ø1" x 36"	Ø14"
8"	11'	40.00	32.37	27.09	17.13	Ø1" x 36"	Ø14"
8"	12'	40.00	29.50	24.66	15.55	Ø1" x 36"	Ø14"
8"	13'	40.85	27.01	22.56	14.18	Ø1" x 36"	Ø14"
8"	14'	37.63	24.82	20.70	12.98	Ø1" x 36"	Ø14"
8"	15'	34.77	22.88	19.06	11.91	Ø1" x 36"	Ø14"
8"	16'	32.21	21.14	17.59	10.94	Ø1" x 36"	Ø14"
8"	17'	29.91	19.57	16.26	10.07	Ø1" x 36"	Ø14"
8"	18'	27.82	18.14	15.05	9.27	Ø1" x 36"	Ø14"
8"	19'	25.91	16.83	13.94	8.54	Ø1" x 36"	Ø14"
8"	20'	24.15	15.63	12.91	7.87	Ø1" x 36"	Ø14"
8"	21'	22.53	14.52	11.97	7.24	Ø1" x 36"	Ø14"
8"	22'	21.03	13.48	11.09	6.66	Ø1" x 36"	Ø14"
8"	23'	19.63	12.51	10.26	6.11	Ø1" x 36"	Ø14"
8"	24'	18.31	11.61	9.49	5.59	Ø1" x 36"	Ø14"
8"	25'	17.08	10.75	8.76	5.11	Ø1" x 36"	Ø14"
8"	26'	15.92	9.95	8.07	4.64	Ø1" x 36"	Ø14"
8"	27'	14.82	9.18	7.42	4.20	Ø1" x 36"	Ø14"
8"	28'	13.78	8.46	6.80	3.79	Ø1" x 36"	Ø14"

Consult factory for internal reinforcement solutions for higher EPA ratings.

LUMENTECH SMART POLE
EPA RATING TABLE - AASHTO

Square Shape

Dimension (in)	Height (ft)	EPA Rating (sq.ft.)				Anchor Bolts (in)	Bolt Circle (in)
		90 MPH	110 MPH	120 MPH	150 MPH		
6"	10'	28.32	16.94	13.26	6.29	Ø1" x 36"	Ø14"
6"	11'	24.70	14.29	10.93	4.56	Ø1" x 36"	Ø14"
6"	12'	21.54	11.96	8.86	2.99	Ø1" x 36"	Ø14"
6"	13'	18.74	9.86	6.99		Ø1" x 36"	Ø14"
6"	14'	16.22	7.96	5.28		Ø1" x 36"	Ø14"
6"	15'	13.94	6.21	3.71		Ø1" x 36"	Ø14"
6"	16'	11.84	4.58	2.24		Ø1" x 36"	Ø14"
6"	17'	9.91	3.07			Ø1" x 36"	Ø14"
6"	18'	8.11				Ø1" x 36"	Ø14"
6"	19'	6.43				Ø1" x 36"	Ø14"
6"	20'	4.84				Ø1" x 36"	Ø14"
6"	21'	3.33				Ø1" x 36"	Ø14"

8"	10'	40.00	34.45	27.64	14.76	Ø1" x 36"	Ø14"
8"	11'	40.00	29.92	23.70	11.92	Ø1" x 36"	Ø14"
8"	12'	40.00	25.96	20.23	9.37	Ø1" x 36"	Ø14"
8"	13'	38.86	22.44	17.13	7.07	Ø1" x 36"	Ø14"
8"	14'	34.56	19.27	14.32	4.95	Ø1" x 36"	Ø14"
8"	15'	30.69	16.38	11.75	2.99	Ø1" x 36"	Ø14"
8"	16'	27.18	13.74	9.39		Ø1" x 36"	Ø14"
8"	17'	23.96	11.28	7.18		Ø1" x 36"	Ø14"
8"	18'	20.98	9.00	5.12		Ø1" x 36"	Ø14"
8"	19'	18.22	6.85	3.17		Ø1" x 36"	Ø14"
8"	20'	15.63	4.83			Ø1" x 36"	Ø14"
8"	21'	13.20	2.90			Ø1" x 36"	Ø14"
8"	22'	10.91				Ø1" x 36"	Ø14"
8"	23'	8.73				Ø1" x 36"	Ø14"
8"	24'	6.65				Ø1" x 36"	Ø14"
8"	25'	4.67				Ø1" x 36"	Ø14"
8"	26'	2.77				Ø1" x 36"	Ø14"

Consult factory for internal reinforcement solutions for higher EPA ratings.

Finishes

Our finishes are extremely durable, resistant, exterior polyester powder coatings that meet AAMA 2604-98 requirements (5-year Florida exposure). Corrosion Resistant Coatings (CRC) are available. Pre-finishes are also available to meet ASTM B-117, ASTM D-1654 (salt-spray resistant), and ASTM D-2247 requirements (humidity resistant).

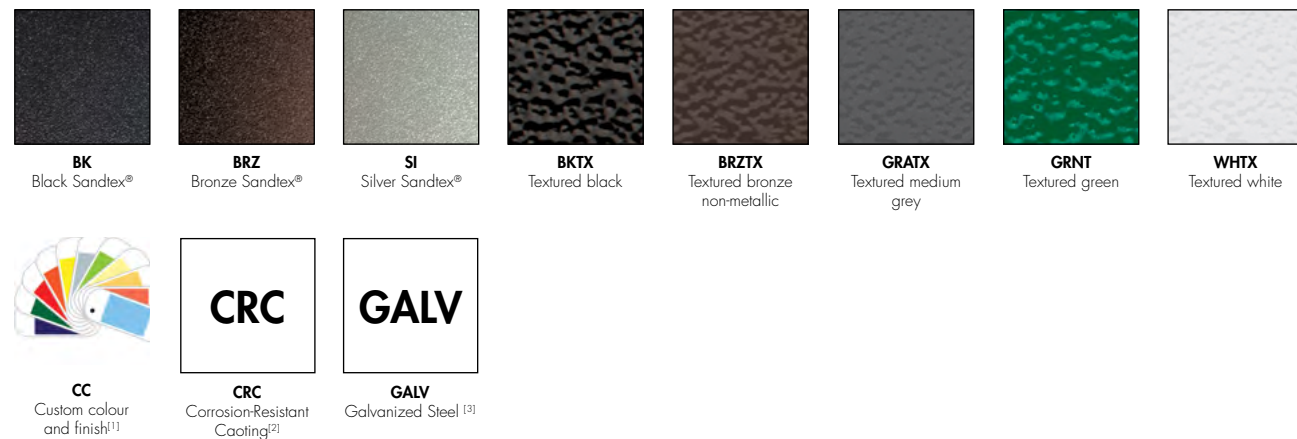

Other requirements met by Lumenpulse finishes include:

- ASTM 3359: Paint and varnishes – Cross-cut test
- ASTM D-1005: Paint and varnishes – Determination of film thickness
- ASTM D523-14 & ASTM D2457-13: Paint and varnishes – Determination of specular gloss of non-metallic paint films at 20 degrees, 60 degrees and 85 degrees
- ASTM D7127: Evaluation of blistering degree
- ASTM D4414 - 95: Standard Practice for Measurement of Wet. Film Thickness by Notch Gages
- ASTM D2369 - 10(2015)e1: Standard Test Method for Volatile Content of Coatings

[1] Specify RAL number followed by "TX" for textured finish (ex: RAL9007TX) or STX for Sandtex finish (ex: RAL9007STX). A textured finish is recommended for optimal surface finish and ease maintenance of poles and base covers. If a finish is not specified with the RAL number (ex: RAL9007), a glossy finish will be provided. Please consult factory for other RAL textures and glosses, or to match alternate color charts. Final color matching results may vary.

[2] Automatically included when a steel pole is specified, Recommended near coastal installation.

Steel: Primer + Powder coating + Clear Coat
Aluminum: Primer + Powder coating + Clear Coat

[3] Only available for steel poles with textured finish (immersion marks may occur), Luminaire can't be match the same color.

Pole Packaging

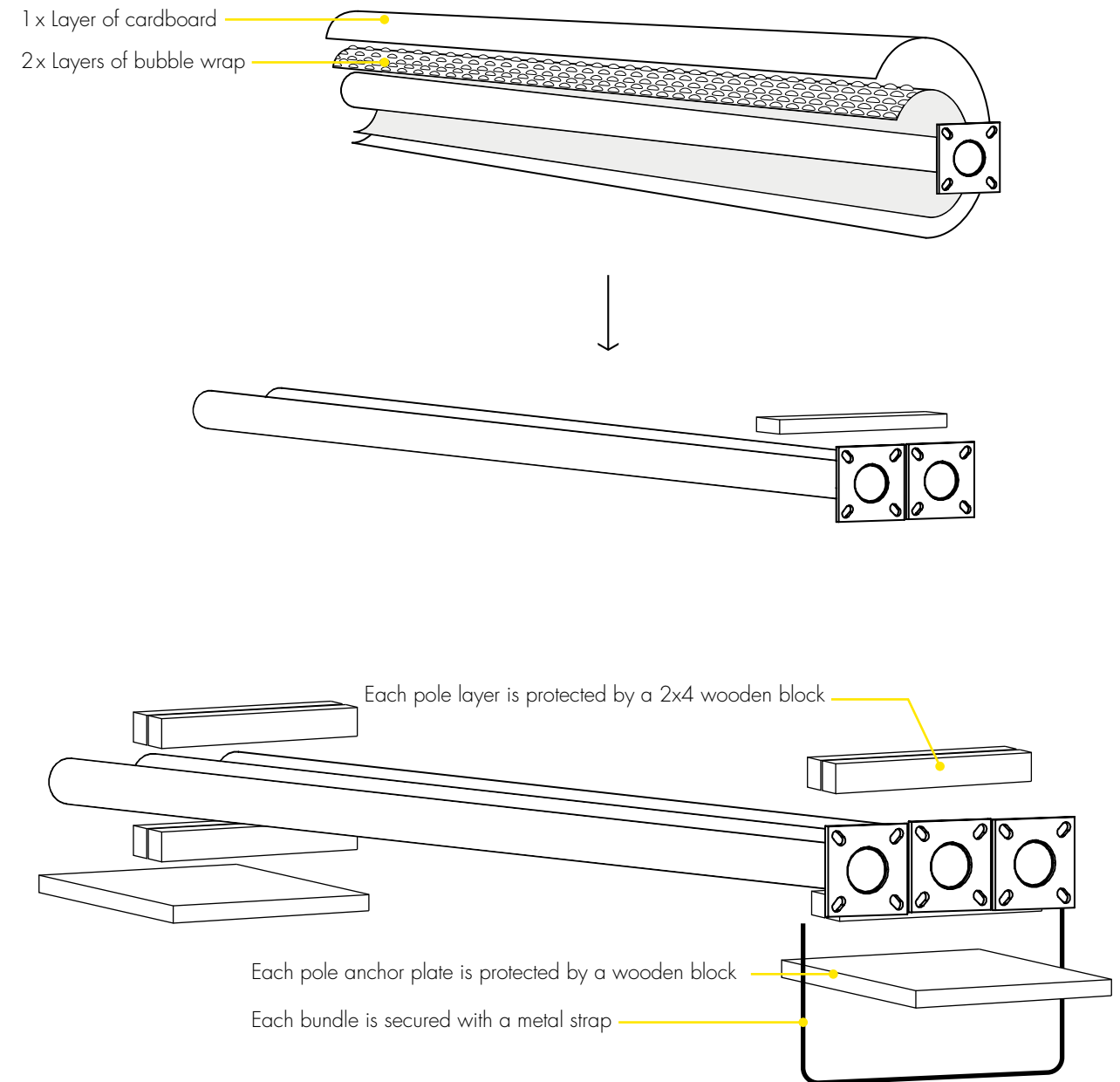

 Each bundle weighs a maximum of 2000lbs (910kg) and is 4ft wide.

 All our poles come with a touch-up paint pen.



Conditions

When selecting a pole and luminaire assembly, the stresses put upon the pole from both the dead-weight load in pounds and the total EPA in square feet of the light fixture and any additional attachments to the pole must be professionally assessed by a qualified engineer. No matter where you are installing outdoor light fixtures and pole assemblies, you are required to properly evaluate that specific wind conditions will not compromise the structural integrity of the assembly.

This guide's sole purpose is to help you determine the maximum EPA (ft. sq.) and weight load using Lumenpulse luminaires, poles, some accessories, and arms. It does not consider all bracketry, signs, decorations, overhead wires, or other equipment that might be mounted to the subject pole. Poles that are to be located in areas of known abnormal conditions will require special consideration.

In such cases, please consult a qualified engineer for more information. This guide will help you select the products needed for your project. However, all selections should be approved by a qualified engineer before purchasing.

Lumenpulse does not assume liability or responsibility for any errors or omissions in the content of this guide or for any damages of any kind related to the use or misuse of information provided.

For further information on EPA calculations, please consult a Lumenpulse representative. If there are discrepancies between this document and a Product Spec Sheet, please refer to the Product Spec Sheet.

For further reading, please refer to our white paper series: "EPA and the ABCs of Wind Safety"
www.lumenpulse.com/knowledge/lighting-outdoor-areas-using-epa

References

American Association of State Highway and Transportation Officials (AASHTO) (1994, 2001, & 2009), Standard Specifications for Structural Supports for Highway Signs, Luminaires and Traffic Signals, American Association of State Highway and Transportation Officials, Washington DC.



**Sales Offices and
Manufacturing Facilities**

Corporate Headquarters

1220 Marie-Victorin Blvd.
Longueuil, QC
J4G 2H9 Canada

T +1.877.937.3003
T +1.514.937.3003
F +1.514.937.6289

info@lumenpulse.com
www.lumenpulse.com

© Lumenpulse™

2021 / 03
147624

